

USER'S MANUAL

IPC960A series

IPC962A series

IPC964A series

Industrial Computers

User's Manual



www.axiomtek.com

Disclaimers

This manual has been carefully checked and believed to contain accurate information. Axiomtek Co., Ltd. assumes no responsibility for any infringements of patents or any third party's rights, and any liability arising from such use.

Axiomtek does not warrant or assume any legal liability or responsibility for the accuracy, completeness or usefulness of any information in this document. Axiomtek does not make any commitment to update the information in this manual.

Axiomtek reserves the right to change or revise this document and/or product at any time without notice.

No part of this document may be reproduced, stored in a retrieval system, or transmitted, in any form or by any means, electronic, mechanical, photocopying, recording, or otherwise, without the prior written permission of Axiomtek Co., Ltd.

©Copyright 2024 Axiomtek Co., Ltd.

All Rights Reserved

July 2024, Version A5

Printed in Taiwan

Safety Precautions

Before getting started, please read the following important safety precautions.

1. The IPC960A/IPC962A/IPC964A Series does not come equipped with an operating system. An operating system must be loaded first before installing any software into the computer.
2. Be sure to ground yourself to prevent static charge when installing the internal components. Use a grounding wrist strap and place all electronic components in any static-shielded devices. Most electronic components are sensitive to static electrical charge.
3. Disconnect the power cord from the IPC960A/IPC962A/IPC964A Series before making any installation. Be sure both the system and the external devices are turned OFF. A sudden surge of power could ruin sensitive components. Make sure the IPC960A/IPC962A/IPC964A Series is properly grounded.
4. Make sure the voltage of the power source is correct before connecting the equipment to the power outlet.
5. Turn OFF the system power before cleaning. Clean the system using a cloth only. Do not spray any liquid cleaner directly onto the screen.
6. Do not leave this equipment in an uncontrolled environment where the storage temperature is below -20°C or above 80°C. It may damage the equipment.
7. Do not open the system's back cover. If opening the cover for maintenance is a must, only a trained technician is allowed to do so. Integrated circuits on computer boards are sensitive to static electricity. To avoid damaging chips from electrostatic discharge, observe the following precautions:
 - Before handling a board or integrated circuit, touch an unpainted portion of the system unit chassis for a few seconds. This will help to discharge any static electricity on your body.
 - When handling boards and components, wear a grounding wrist strap, available from most electronic component stores.

Classification

1. Degree of protection against electric shock: not classified
2. Degree of protection against the ingress of water: none
3. Equipment not suitable for use in the presence of a flammable anesthetic mixture with air or with oxygen or nitrous oxide.
4. Mode of operation: Continuous
5. Type of protection against electric shock: Class I equipment

General Cleaning Tips

You may need the following precautions before you begin to clean the computer. When you clean any single part or component for the computer, please read and understand the details below fully.

When you need to clean the device, please rub it with a piece of dry cloth.

1. Be cautious of the tiny removable components when you use a vacuum cleaner to absorb the dirt on the floor.
2. Turn the system off before you start to clean up the component or computer.
3. Never drop the components inside the computer or get circuit board damp or wet.
4. Be cautious of all kinds of cleaning solvents or chemicals when you use it for the sake of cleaning. Some individuals may be allergic to the ingredients.
5. Try not to put any food, drink or cigarette around the computer.

Cleaning Tools

Although many companies have created products to help improve the process of cleaning your computer and peripherals users can also use household items to clean their computers and peripherals. Below is a listing of items you may need or want to use while cleaning your computer or computer peripherals.

Keep in mind that some components in your computer may require designated products for cleaning. If this is the case it will be mentioned in the cleaning instructions.

- Cloth: A piece of cloth is the best tool to use when rubbing up a component. Although paper towels or tissues can be used on most hardware as well, we still recommend you to rub it with a piece of cloth.
- Water or rubbing alcohol: You may moisten a piece of cloth a bit with some water or rubbing alcohol and rub it on the computer. Unknown solvents may be harmful to the plastics parts.
- Vacuum cleaner: Vacuuming the dust, dirt, hair, cigarette particles, and other particles out of a computer can be one of the best methods of cleaning a computer. Over time these items can restrict the airflow in a computer and cause circuitry to corrode.
- Cotton swabs: Cotton swabs moistened with rubbing alcohol or water are excellent tools for wiping hard to reach areas in your keyboard, mouse, and other locations.
- Foam swabs: Whenever possible it is better to use lint free swabs such as foam swabs.



Note: It is strongly recommended that you should shut down the system before you start to clean any single components.



Note: Please check the temperature of system surface before maintenance.

Please follow the steps below:

1. Close all application programs;
2. Close operating software;
3. Turn off power switch;
4. Remove all device;
5. Pull out the power cable.

Scrap Computer Recycling

Please inform the nearest Axiomtek distributor as soon as possible for suitable solutions in case computers require maintenance or repair; or for recycling in case computers are out of order or no longer in use.

Trademark Acknowledgments

Axiomtek is a trademark of Axiomtek Co., Ltd.

Intel® and Pentium® are registered trademarks of Intel Corporation.

Windows 10 64-bit, Windows 10 IoT Enterprise 64-bit, Windows 11 64-bit, are trademarks of Microsoft Corporation.

Other brand names and trademarks are the properties and registered brands of their respective owners.

Table of Contents

| | |
|---|-----------|
| Safety Precautions | iii |
| Classification | iv |
| General Cleaning Tips | iv |
| Cleaning Tools | v |
| Scrap Computer Recycling..... | vi |
| SECTION 1 INTRODUCTION..... | 1 |
| 1.1 General Description..... | 1 |
| 1.2 System Specifications..... | 2 |
| 1.2.1 System Features..... | 2 |
| 1.2.2 CPU Level..... | 2 |
| 1.2.3 Specification | 3 |
| 1.2.4 Operating Temperature..... | 6 |
| 1.2.5 Certification | 7 |
| 1.3 System Dimensions..... | 8 |
| 1.4 System Outlets | 10 |
| 1.5 Packing List | 12 |
| 1.6 M/B Block Diagram..... | 13 |
| 1.7 Jumper Settings | 14 |
| 1.7.1 Restore BIOS Optimal Defaults (SW2)..... | 14 |
| 1.8 Connectors..... | 15 |
| 1.8.1 MINI Card Slot (CN7)..... | 16 |
| 1.8.2 LAN+USB3.2 (CN8, CN9)..... | 17 |
| 1.8.3 DVI-D Connector (DVI1)..... | 19 |
| 1.8.4 DP++ connector (CN2)..... | 20 |
| 1.8.5 HDMI Connector (CN1) | 20 |
| 1.8.6 USB 3.2 connector (H610E Only support USB2.0) (CN6) | 21 |
| 1.8.7 Audio Connector (CN4)..... | 22 |
| 1.8.8 DC-in Phoenix Power Connector (CN13)..... | 22 |
| 1.8.9 COM Port Connector (COM1) | 23 |
| 1.8.10 M.2 2280 Key M NVMe SSD (CN5)..... | 24 |
| 1.8.11 SATA Power Connector (SATAPWR1~2) | 25 |
| 1.8.12 SATA Connector (SATA1~SATA2) | 25 |
| 1.8.13 Power On/OFF Button & LED (SW2)..... | 26 |
| 1.8.14 Extended control Connector (CN12) | 27 |
| 1.8.15 MIO530 Module Kit, M.2 Key B+M.2 Key E (Q670 sku Only) | 28 |
| 1.8.16 Flexible IO - AX93511 | 30 |
| 1.8.17 Flexible IO - AX93512 | 31 |
| 1.8.18 Flexible IO – AX93516 | 35 |
| 1.8.19 Flexible IO – AX93519 | 36 |
| 1.8.20 Flexible IO – MIO160..... | 38 |
| 1.8.21 Riser card – EIO121, EIO122, EIO141, EIO142..... | 39 |
| SECTION 2 HARDWARE INSTALLATION | 43 |
| 2.1 Installing the Processor | 43 |
| 2.2 Procedure of Installation | 44 |
| 2.3 Installing the Memory Module..... | 45 |
| 2.4 Installing the Hard Disk Drive | 46 |
| 2.5 Installing the extension I/O module | 47 |
| 2.6 Installing the Fan Module | 50 |

| | | |
|--|--|------------|
| 2.7 | Installing PCI or PCIe Card | 51 |
| 2.7.1 | Installing PCI or PCIe card | 51 |
| 2.7.2 | The limitation of an add-on card | 54 |
| 2.8 | Installing the Mini Card Module | 62 |
| 2.9 | Installing the 5G Wireless Module | 63 |
| 2.10 | Installing the M.2 key E Wireless Module | 65 |
| 2.11 | Installing the NVMe SSD Module | 66 |
| 2.12 | Mounting..... | 67 |
| SECTION 3 AMI BIOS UTILITY | | 73 |
| 3.1 | Starting | 73 |
| 3.2 | Navigation Keys | 74 |
| 3.3 | Main Menu | 75 |
| 3.4 | Advanced..... | 76 |
| 3.5 | Chipset Menu | 93 |
| 3.6 | Security Menu | 102 |
| 3.7 | Boot Menu | 104 |
| 3.8 | Save & Exit Menu | 105 |
| APPENDIX A WATCHDOG TIMER | | 107 |
| A.1 | About Watchdog Timer..... | 107 |
| A.2 | Sample Program | 107 |
| APPENDIX B WAKE on LAN | | 111 |
| | How to Set up Wake on LAN..... | 111 |
| APPENDIX D HDD HOT-SWAPPABLE..... | | 115 |
| | Removing Hot-Swappable storage..... | 116 |

SECTION 1 INTRODUCTION



This chapter contains general information and detailed specifications of the IPC960A/IPC962A/IPC964A Series. Chapter 1 includes the following sections:

- General Description
- System Specifications
- Dimensions
- I/O Outlets
- Jumper Settings
- Connectors
- Package List

1.1 General Description

The IPC960A, IPC962A and IPC964A are fan-less systems with an optional fan module that can support LGA1700 socket for Intel® 13th/12th generation Core™ i9/i7/i5/i3 processors. The IPC960A, IPC962A, and IPC964A are also built with a rugged design that makes the system suitable for the most durable operation.

For operation systems, the IPC960A/IPC962A/IPC964A series not only supports Windows® 11 64-bit, Windows® 10 64-bit and Ubuntu, but also supports embedded OS.

The IPC960A/IPC962A/IPC964A Series supports two hard-drive bays to make it easy for customers to install and maintain the system.

1.2 System Specifications

1.2.1 System Features

- Front I/O design
- Optional extension system IO module
- Optional 5G network (Q670E)
- Intelligent power management (Ignition, USB power on/off control)
- Supports Intel® RAID (Q670E)
- EN61000-6-2 certified

1.2.2 CPU Level

- Socket LGA1700 for 13th/12th Generation Intel® Core™ i9/i7/i5/i3 processors, up to 65W
- Below is a list of supported CPUs.

| Generation | Proc No | WATT | Performance-core base frequency | Efficient-core base frequency |
|-------------|------------|------|---------------------------------|-------------------------------|
| Raptor Lake | i9-13900E | 65W | 1.8 GHz | 1.3 GHz |
| Raptor Lake | i9-13900TE | 35W | 1.0 GHz | 800 MHz |
| Raptor Lake | i7-13700E | 65W | 1.9 GHz | 1.3 GHz |
| Raptor Lake | i7-13700TE | 35W | 1.1 GHz | 800 MHz |
| Raptor Lake | i5-13500E | 65W | 2.4 GHz | 1.5 GHz |
| Raptor Lake | i5-13500TE | 35W | 1.3 GHz | 1.1 GHz |
| Raptor Lake | i3-13100E | 65W | 3.3 GHz | 3.3 GHz |
| Raptor Lake | i3-13100TE | 35W | 2.4 GHz | 2.4 GHz |
| Alder Lake | i9-12900E | 65W | 2.3 GHz | 1.7 GHz |
| Alder Lake | i9-12900TE | 35W | 1.1 GHz | 1.0 GHz |
| Alder Lake | i7-12700E | 65W | 2.1 GHz | 1.6 GHz |
| Alder Lake | i7-12700TE | 35W | 1.4 GHz | 1.0 GHz |
| Alder Lake | i5-12500E | 65W | 2.9 GHz | |
| Alder Lake | i5-12500TE | 35W | 1.9 GHz | |
| Alder Lake | i3-12100E | 60W | 3.2 GHz | |
| Alder Lake | i3-12100TE | 35W | 2.1 GHz | |
| Alder Lake | G7400E | 46W | 3.6 GHz | |
| Alder Lake | G7400TE | 35W | 3.0 GHz | |
| Alder Lake | G6900E | 46W | 3.0 GHz | |
| Alder Lake | G6900TE | 35W | 2.4 GHz | |

1.2.3 Specification

| | IPC960A | IPC962A | IPC960A | IPC962A | IPC964A |
|--|---|--|-------------------|--------------------------|--------------------|
| System chipset | H610E | H610E | Q670E | Q670E | Q670E |
| BIOS | AMI BIOS with Smart View and Customer CMOS Backup | | | | |
| System memory | 2x DDR5 4800/4000 un-buffered SO-DIMM 262-pin, max up to 64GB | | | | |
| Ethernet | 1 x 2.5GbE Intel I226-V 1 x 1GbE LAN (Intel@ 1219-LM); with Intel AMT (Q670E) | | | | |
| Serial | 1 x RS232/422/485 (default RS232) COM1 | | | | |
| USB | 2 x USB3.2 Gen2x1(10G) 2 x USB3.2 Gen1x1(5G) 2 x USB2.0 | 6 x USB3.2 Gen2x1 (10G) 1 x USB2.0 (internal, type A, up to 30mm) | | | |
| Display | 1 x DVI-D with 1920 x 1200 resolution supported 1 x HDMI with 4096 x 2160 resolution supported 1 x DP++ with 4096 x 2160 resolution supported | | | | |
| Audio | 1 x 3.5mm jack for Line out and Mic-in | | | | |
| TPM | 1 x TPM 2.0 on board | | | | |
| Extension system I/O module (optional) | AX93511, AX93512, AX93516, AX93519, MIO160 | | | | |
| Riser card | N/A | EIO121 EIO122 | N/A | EIO121 EIO122 | EIO141 EIO142 |
| Expansions | 1 x mPCIe socket w/ SIM slot | 1 x mPCIe socket w/ SIM slot 1 x M.2 key E 2230 + 1 x M.2 key B 3052 w/ SIM slot (optional) | | | |
| Storage | 2 x 2.5" HDD/SSD tray (7/9.5/15mm height) 1 x M.2 key M 2280 socket (PCIe x4 Gen4, Q670E) | | | | |
| System indicator | 1 x HDD/SSD access LED 3 x user's LED | | | | |
| Power input | Power input 18 to 36 Vdc 1 x switch for power on/off with LED (default ATX) 1 x 4-pin Terminal Block for DC input 1 x 4-pin Terminal Block for ignition control, remote power and remote LED | | | | |
| Typical | 24 Vdc | | | | |
| Inrush current | +24V/10.8A | | | | |
| Power rating | 18-36Vdc, 8-4A | 18-36Vdc, 14.67-7.33A | 18-36Vdc, 8-4A | 18-36Vdc, 14.67-7.33A | 18-36Vdc, 18-9A |
| Storage temperature | -20°C -80°C | | | | |

| | | | | | |
|------------|---|-------------------|--------------------|-------------------|-------------------|
| Humidity | 10%-90% (non-condensing) | | | | |
| Vibration | IPC960A: IEC 60068-2-64 (with SSD: 3Grms STD, random, 5 to 500 Hz, 1 hr/axis) IPC962A/IPX964A: IEC 60068-6-4 (W/SSD: 1Grms STD, random, 5-500 Hz, 1 hr/axis) | | | | |
| Shock | IEC 60068-2-27 (with SSD: 50G, half sine, 11 ms duration) | | | | |
| Dimensions | 83.5x192x260 mm | 170x192x260 mm | 83.5x192x260 mm | 170x192x260 mm | 205x192x260 mm |



Note: Since Gen. 2 SSD with JMicron controller has a compatibility issue with Intel PCH, it is strongly recommended to use Gen. 3 SSD on system.



Note: Please fix the system power input in 24Vdc when plugging an add-on card.

Extension system I/O module

- AX93511 4 x RS-232/422/485 module (default RS-232)
- AX93512 2 x RS-232/422/485 w/ isolated 1.5KVDC and 8-in/8-out isolated 1.5KVDC DIO
- AX93516 4 x RS232/422/485 w/isolated 2KVDC module
- AX93519 2 x RS232/422/485 + 1 G.E. LAN (I210-AT) + 2 USB3.2 Gen1x1 (5G) (Q670E)
AX93519 2 x RS232/422/485 + 1 G.E. LAN (I210-AT) + 2 USB2.0 (H610E)
- MIO160 6 x Serial port (4-wire RS232: TXD/RXD/RTS/CTS)/422/485 isolated 1.5kVDC & 2 CAN bus with isolated 1.5kVDC module (supports the CAN 2.0A and CAN2.0B protocol specification)



Note: The RS-485 auto flow control only supports below formats to communicate data:

- 8 data bits + 1 stop bit
- 8 data bits + 1 parity bit + 1 stop bit
- 8 data bits + 1 parity bit + 2 stop bits
- 8 data bits + 2 stop bits
- 7 data bits + 1 parity bit (even or odd) + 2 stop bits

Riser card

- EIO121: 1 PCIe x16 Gen4 + 1 PCIe x8 (x4 signal) Gen4
 - 1 USB2.0 type A 180D
 - 2 Fan connector
 - 2 8-pin power connectors
 - 1 4-pin power connector
- EIO122: 1 PCIe x16 Gen4 + 1 PCI
 - 1 USB2.0 type A 180D
 - 2 Fan connector
 - 2 8-pin power connectors

- 1 4-pin power connector
- EIO141: 1 PCIe x16 Gen4 + 1 PCIe x8 Gen3(x4 signal) + 2 PCIe x4 Gen4 (open ended connector)
 - 1 USB2.0 type A 180D
 - 1 Fan connector
 - 2 8-pin power connectors
 - 1 4-pin power connector
- EIO142: 1 PCIe x16 Gen4 + 1 PCIe x4 Gen4 (open ended connector) + 2 PCI
 - 1 USB2.0 type A 180D
 - 1 Fan connector
 - 2 8-pin power connectors
 - 1 4-pin power connector



Note: The maximum power rating for expansion slots at 70°C cannot exceed the following value:

The maximum loading of +3.3V+5V+12V+24V<350W (EIO141, EIO142)

The maximum loading of +3.3V+5V+12V+24V<230W (EIO121, EIO122)



Note: 12V maximum loading for 2 x 8-pin connectors (ATX2-3) are 300W. (EIO141, EIO142)

12V maximum loading for 2 x 8-pin connectors (ATX2-3) are 200W. (EIO121, EIO122)



Note: 24V maximum loading for 1 x 4-pin connector (ATX1) is <(120W).





Note: The system power rating may thus be changed based on differing combinations of attached devices.

1.2.4 Operating Temperature

Below is a list of system operating temperature w/ Intel® Core™ processor and industrial wide-temp SSD.

| Generation | Proc No | WATT | Operating Temperature (0.7 m/s air flow) | Performance-core base frequency | Efficient-core base frequency |
|-------------|------------|------|---|---------------------------------|-------------------------------|
| Raptor Lake | i9-13900E | 65W | -20°C-50°C | 1.8 GHz | 1.3 GHz |
| Raptor Lake | i9-13900TE | 35W | -20°C-60°C | 1.0 GHz | 800 MHz |
| Raptor Lake | i7-13700E | 65W | -20°C-50°C | 1.9 GHz | 1.3 GHz |
| Raptor Lake | i7-13700TE | 35W | -20°C-60°C | 1.1 GHz | 800 MHz |
| Raptor Lake | i5-13500E | 65W | -20°C-50°C | 2.4 GHz | 1.5 GHz |
| Raptor Lake | i5-13500TE | 35W | -20°C-60°C | 1.3 GHz | 1.1 GHz |
| Raptor Lake | i3-13100E | 65W | -20°C-50°C | 3.3 GHz | 3.3 GHz |
| Raptor Lake | i3-13100TE | 35W | -20°C-60°C | 2.4 GHz | 2.4 GHz |
| Alder Lake | i9-12900E | 65W | -20°C-50°C | 2.3 GHz | 1.7 GHz |
| Alder Lake | i9-12900TE | 35W | -20°C-60°C | 1.1 GHz | 1.0 GHz |
| Alder Lake | i7-12700E | 65W | -20°C-50°C | 2.1 GHz | 1.6 GHz |
| Alder Lake | i7-12700TE | 35W | -20°C-60°C | 1.4 GHz | 1.0 GHz |
| Alder Lake | i5-12500E | 65W | -20°C-50°C | 2.9 GHz | |
| Alder Lake | i5-12500TE | 35W | -20°C-60°C | 1.9 GHz | |
| Alder Lake | i3-12100E | 60W | -20°C-50°C | 3.2 GHz | |
| Alder Lake | i3-12100TE | 35W | -20°C-60°C | 2.1 GHz | |
| Alder Lake | G7400E | 46W | -20°C-50°C | 3.6 GHz | |
| Alder Lake | G7400TE | 35W | -20°C-60°C | 3.0 GHz | |
| Alder Lake | G6900E | 46W | -20°C-50°C | 3.0 GHz | |
| Alder Lake | G6900TE | 35W | -20°C-60°C | 2.4 GHz | |

 Note: The IPC system may cause CPU frequency hopping when operating in an extremely high temperature environment, and thermal throttling may occur when the system remains in full loading conditions.

 Note: The performance of the system might be adversely affected when operating at a temperature above the system's limitation or with an unrecommended processor.

 Note: If the operating temperature is above 35°C, it is recommended to use a wide temperature SSD on the device.

1.2.5 Certification

- CE (EN 61000-6-4, EN 61000-6-2)
- FCC



Note: All specifications and images are subject to change without notice.

1.3 System Dimensions

The following diagrams show you dimensions and outlines of the IPC960A/IPC962A/IPC964A Series.

IPC960A

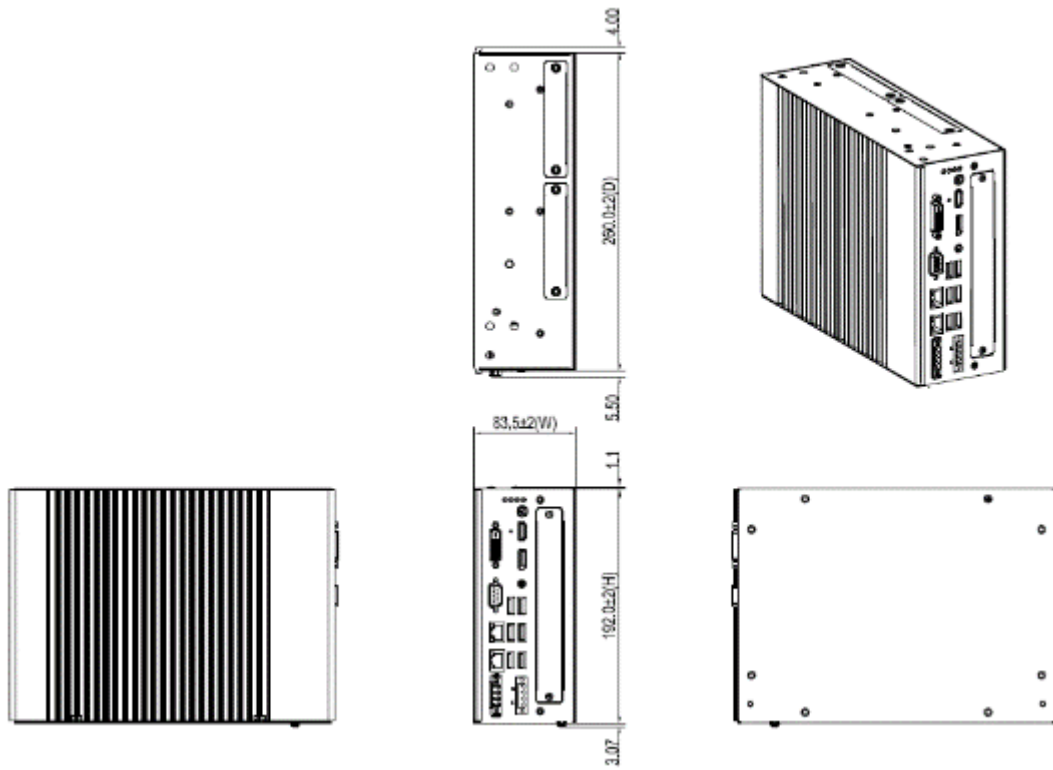

IPC962A

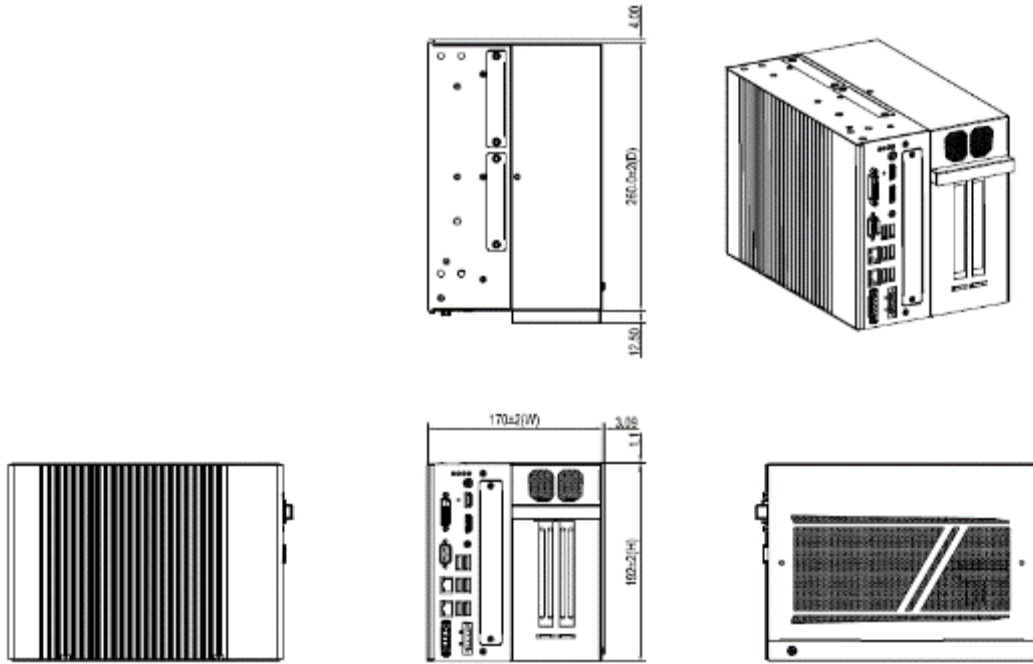

IPC964A

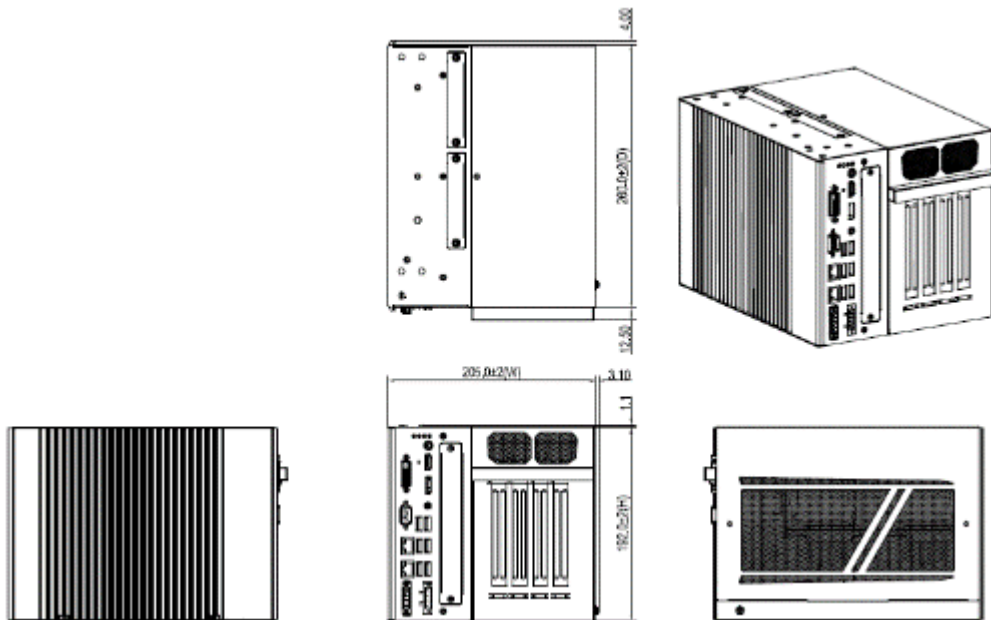

1.4 System Outlets

The following figures show locations of the IPC960A series system outlets.

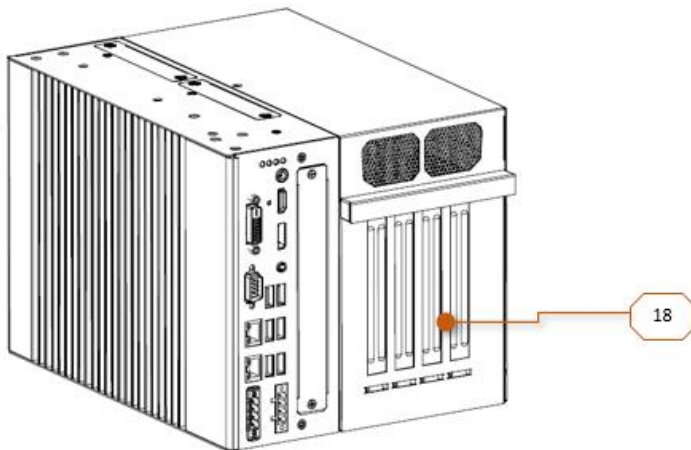
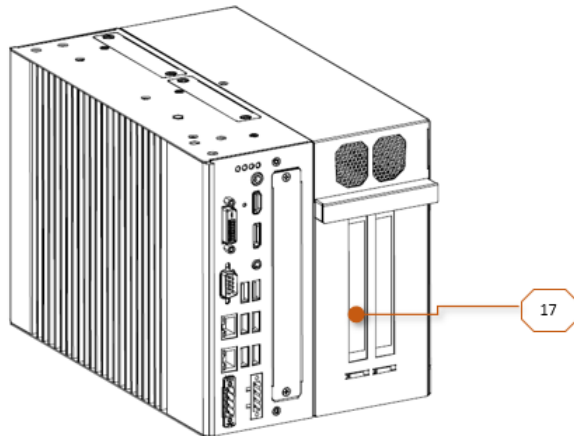
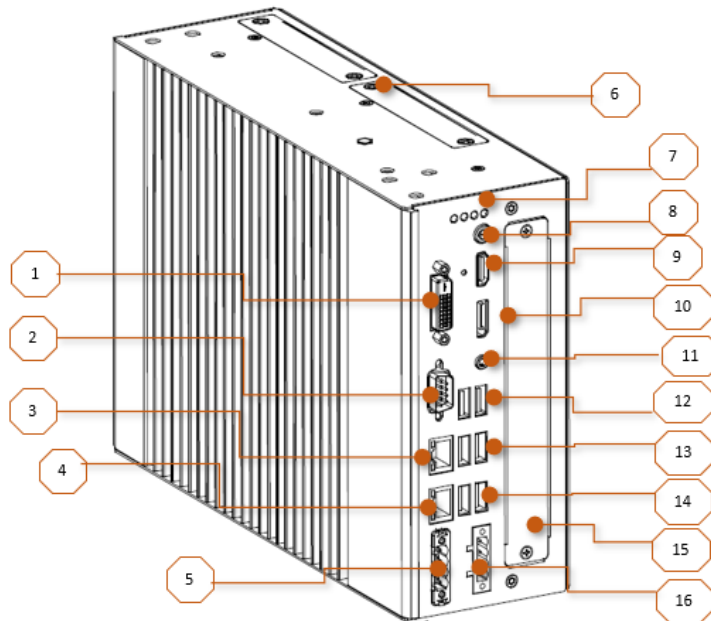

| Mark | Description |
|------|--|
| 1 | DVI-D with 1920 x 1200 resolution |
| 2 | RS232/422/485 (default RS232) COM1 |
| 3 | 1GbE Intel I219-LM |
| 4 | 2.5GbE Intel I226-V |
| 5 | 4-pin Terminal Block for ignition control, remote power and remote LED |
| 6 | 2 x 2.5" HDD/SSD tray |
| 7 | 1 x HDD/SSD access LED 3 x user's LED |
| 8 | Button for power on/off with LED (default ATX) |
| 9 | HDMI with 4096 x 2160 resolution |
| 10 | DP++ with 4096 x 2160 resolution |
| 11 | 3.5mm jack for Mic-in and Line-out |
| 12 | 2 x USB2.0(H610E) or 2 x USB3.2 Gen2x1 10G (Q670E) |
| 13 | 2 x USB3.2 Gen1x1 5G(H610E) or 2 x USB3.2 Gen2x1 10G(Q670E) |
| 14 | 2 x USB3.2 Gen2x1 10G |
| 15 | Extension system IO window for AX93511, AX93512, AX93516, AX93519 and MIO160 |
| 16 | 4-pin Terminal Block for DC input |
| 17 | Expansion slots - EIO121 or EIO122 (riser card) |
| 18 | Expansion slots - EIO141 or EIO142 (riser card) |

1.5 Packing List

The package bundled with your IPC960A/IPC962A/IPC964A Series should contain the following items:

- IPC960A/IPC962A/IPC964A Series unit x 1
- Screw pack x 1
- Foot pad x 4
- CPU grease x 1
- Terminal block x 2
- Holder bracket kit x 1 (for IPC962A/IPC964A)

If you cannot find this package or any items are missing, please contact Axiomtek distributors immediately.

1.6 M/B Block Diagram

The following diagram shows you the M/B block diagram of PSB515.

BLOCK DIAGRAM

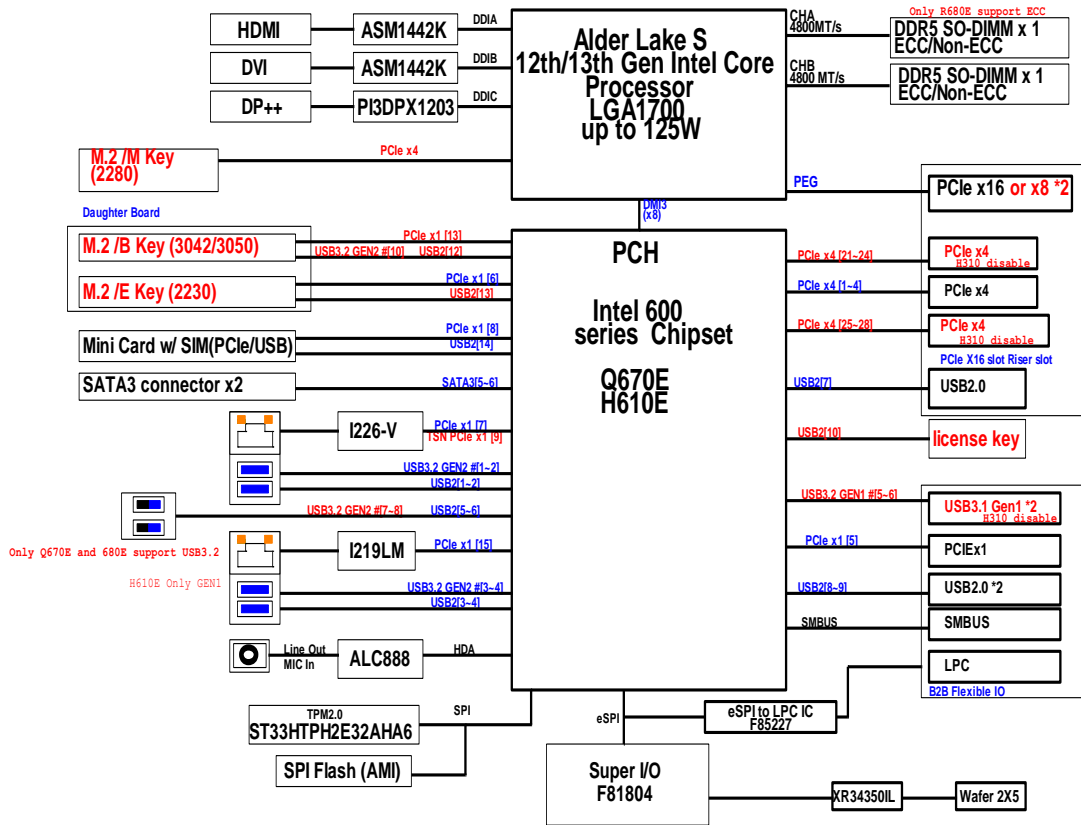

1.7 Jumper Settings

Properly configure jumper settings on the PSB515 to meet your application purpose. Below you can find a summary table of all jumpers and onboard default settings.



Note: How to setup Jumpers

Illustrations below show that a cap on a jumper is to "close" the jumper, whereas that off a jumper is to "open" the jumper.



1.7.1 Restore BIOS Optimal Defaults (SW2)

Touch Switches push (down) for 5 seconds. Doing this procedure can restore BIOS optimal defaults.

| Function | Setting |
|-------------------------------|----------------|
| Normal operation (Default) | OPEN |
| Restore BIOS optimal defaults | Push (down) 5s |



1.8 Connectors

Connectors connect the board with other parts of the system. Loose or improper connection might cause problems. Make sure all connectors are properly and firmly connected.

Here is a table summarizing all connectors on the board.

| Connector | Label |
|---|------------|
| MINI Card slot | CN7 |
| LAN1+USB3.2 Gen2x1 10Gb/s (H610E Only support Gen1x1 5Gb/s) | CN8 |
| LAN2+USB3.2 Gen2x1 10Gb/s | CN9 |
| DVI-D connector | DVI1 |
| DP++ connector | CN2 |
| USB 3.2 connector (H610E Only support USB2.0) | CN6 |
| Audio connector | CN4 |
| DC-in Phoenix power connector | CN13 |
| HDMI connector | CN1 |
| M.2 2280 Key M PCIe x4 Gen4 (Q670E sku only) | CN5 |
| COM port connector | COM1 |
| SATA Power connector (+5V Only) | SATAPWR1~2 |
| SATA III connector | SATA1~2 |
| DDR5 SO-DIMM (262 Pin) | SODIMM1~2 |
| Power button | SW1 |
| Remote SW/LED; IGN control | CN12 |
| MIO530 Module Kit, M2 Key B, M2 Key E (Q670E sku Only) | CN3 |
| Flexible IO-AX93511 COM x4 (RS232/422/485) | SCN1 |
| Flexible IO-AX93516 isolated COM x4 (RS232/422/485) | |
| Flexible IO-AX93512 isolated COM x2 (RS232/422/485) & 8in/8out DIO | |
| Flexible IO-AX93519 COM x2 (RS232/422/485), USB x2 & LAN1 | |
| Flexible IO-MIO160 6 x Serial port (4-wire RS232: TXD/RXD/RTS/CTS)/422/485 isolated 1.5kVDC & 2 CAN bus with isolated 1.5kVDC module (supports the CAN 2.0A and CAN2.0B protocol specification) | |
| Riser card - EIO141 1 PCIe x 16 Gen4 + 1 PCIe x8 Gen3(x4 signal) + 2 PCIe x4 Gen4 (open ended connector) | SHB1+SHB2 |
| Riser card - EIO142 1 PCIe x 16 Gen4 + 1 PCIe x4 Gen4 (open ended connector) + 2 PCI | |
| Riser card - EIO121: 1 PCIe x 16 Gen4 + 1 PCIe x8 (x4 signal) Gen4 | |
| Riser card - EIO122: 1 PCIe x16 Gen4 + 1 PCI | |

1.8.1 MINI Card Slot (CN7)

A PCI-Express Mini Card connector is located on the top side. The pin definitions are as shown below.

| Pins | Signals | Pins | Signals |
|------|----------|------|------------|
| 1 | WAKE# | 2 | +3.3VSB |
| 3 | No use | 4 | GND |
| 5 | No use | 6 | +1.5V |
| 7 | CLKREQ# | 8 | SIM_PWR |
| 9 | GND | 10 | SIM-DATA |
| 11 | REFCLK- | 12 | SIM_CLK |
| 13 | REFCLK+ | 14 | SIM-RESET |
| 15 | GND | 16 | SIM-VPP |
| 17 | No use | 18 | GND |
| 19 | No use | 20 | W_DISABLE# |
| 21 | GND | 22 | PERST# |
| 23 | PE_RXN3/ | 24 | +3.3VSB |
| 25 | PE_RXP3/ | 26 | GND |
| 27 | GND | 28 | +1.5V |
| 29 | GND | 30 | No use |
| 31 | PE_TXN3/ | 32 | No use |
| 33 | PE_TXP3/ | 34 | GND |
| 35 | GND | 36 | USB_D8- |
| 37 | GND | 38 | USB_D8+ |
| 39 | +3.3VSB | 40 | GND |
| 41 | +3.3VSB | 42 | No use |
| 43 | GND | 44 | No use |
| 45 | No use | 46 | No use |
| 47 | No use | 48 | +1.5V |
| 49 | No use | 50 | GND |
| 51 | No use | 52 | +3.3VSB |

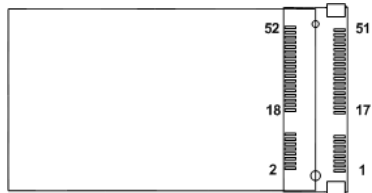

Note: The on-board full-size PCI Express Mini Card slot offers PCIe and USB interface.

1.8.2 LAN+USB3.2 (CN8, CN9)

The system has two RJ-45 connectors: LAN1 and LAN2. Ethernet connection can be established by plugging one end of the Ethernet cable into this RJ-45 connector and the other end (phone jack) to a 2500/1000/100/10-Base-T hub.

| Port | LAN LED | Descriptions |
|------|---------|---|
| CN8 | A | Speed LED : Link 10 off Link 100 Green Link 1000 Orange |
| | B | Active Link LED : Active Yellow Blinking |
| CN9 | A | Speed LED : Link 10 off Link 100 off Link 1000 Orange Link 2500 Green |
| | B | Active Link LED : Active Yellow Blinking |

The Universal Serial Bus connectors are compliant with USB 3.2 Gen2x1 10Gb/s ,(H610E CN8 Only support Gen1x1 5Gb/s) and ideal for installing USB peripherals such as scanners, cameras and USB devices.

| Pins | Signal USB Port 0 | Pins | Signal USB Port 1 |
|------|-----------------------------------|------|-----------------------------------|
| 1 | USB_VCC (+5V level standby power) | 10 | USB_VCC (+5V level standby power) |
| 2 | USB_Data2- | 11 | USB_Data3- |
| 3 | USB_Data2+ | 12 | USB_Data3+ |
| 4 | GND | 13 | GND |
| 5 | SSRX2- | 14 | SSRX3- |
| 6 | SSRX2+ | 15 | SSRX3+ |
| 7 | GND | 16 | GND |
| 8 | SSTX2- | 17 | SSTX3- |
| 9 | SSTX2+ | 18 | SSTX3+ |

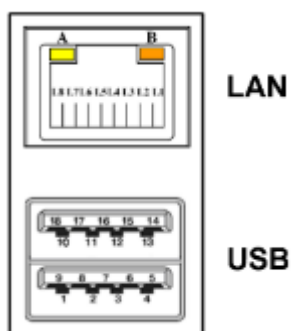

1.8.3 DVI-D Connector (DVI1)

The high rise DVI-D connector provides transmission of fast and high-quality video signals between a source device (graphics card) and a display device (monitor).

| Pin | Signal | Pin | Signal | Pin | Signal |
|-----|--------------|-----|----------|-----|--------|
| 1 | TX2- | 9 | TX1- | 17 | TX0- |
| 2 | TX2+ | 10 | TX1+ | 18 | TX0+ |
| 3 | Ground | 11 | Ground | 19 | Ground |
| 4 | NC | 12 | NC | 20 | NC |
| 5 | NC | 13 | NC | 21 | NC |
| 6 | DVI_SPD_CLK | 14 | VGAVCC | 22 | Ground |
| 7 | DVI_SPD DATA | 15 | Ground | 23 | TXC+ |
| 8 | NC | 16 | HPDETECT | 24 | TXC- |

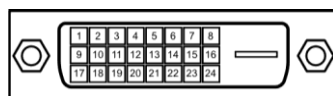

1.8.4 DP++ connector (CN2)

The DP++ is a compact digital interface which is capable of transmitting high-definition video and high-resolution audio over a single cable.

| Pin | Signal | Pin | Signal |
|-----|------------|-----|-----------------|
| 1 | LANE 0 | 2 | GND |
| 3 | LANE 0# | 4 | LANE 1 |
| 5 | GND | 6 | LANE 1# |
| 7 | LANE 2 | 8 | GND |
| 9 | LANE 2# | 10 | LANE 3 |
| 11 | GND | 12 | LANE 3# |
| 13 | Detect Pin | 14 | GND |
| 15 | AUX CH | 16 | GND |
| 17 | AUX CH# | 18 | Hot Plug Detect |
| 19 | GND | 20 | DP_PWR(3.3V) |

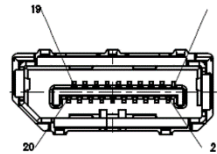

1.8.5 HDMI Connector (CN1)

The HDMI (High-Definition Multimedia Interface) is a compact digital interface which is capable of transmitting high-definition video and high-resolution audio over a single cable.

| Pins | Signals | Pins | Signals |
|------|-----------------|------|-----------------|
| 1 | HDMI OUT_DATA2+ | 11 | GND |
| 2 | GND | 12 | HDMI OUT Clock- |
| 3 | HDMI OUT_DATA2- | 13 | N.C. |
| 4 | HDMI OUT_DATA1+ | 14 | N.C. |
| 5 | GND | 15 | HDMI OUT_SCL |
| 6 | HDMI OUT_DATA1- | 16 | HDMI OUT_SDA |
| 7 | HDMI OUT_DATA0+ | 17 | GND |
| 8 | GND | 18 | +5V |
| 9 | HDMI OUT_DATA0- | 19 | HDMI_HTPLG |
| 10 | HDMI OUT Clock+ | | |

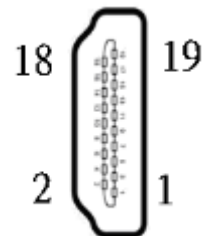

1.8.6 USB 3.2 connector (H610E Only supports USB2.0) (CN6)

The Universal Serial Bus connectors are compliant with USB 3.2 10Gb/s (H610E Only supports USB2.0 480Mbps), providing ideal interfaces ideal for installing USB peripherals such as a keyboard, mouse, scanner, etc.

| Pins | Signal USB Port 0 | Pins | Signal USB Port 1 |
|------|-----------------------------------|------|-----------------------------------|
| 1 | USB_VCC (+5V level standby power) | 10 | USB_VCC (+5V level standby power) |
| 2 | USB_Data2- | 11 | USB_Data3- |
| 3 | USB_Data2+ | 12 | USB_Data3+ |
| 4 | GND | 13 | GND |
| 5 | SSRX2- | 14 | SSRX3- |
| 6 | SSRX2+ | 15 | SSRX3+ |
| 7 | GND | 16 | GND |
| 8 | SSTX2- | 17 | SSTX3- |
| 9 | SSTX2+ | 18 | SSTX3+ |

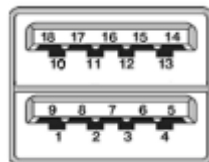

1.8.7 Audio Connector (CN4)

This audio jack support for Audio Mic-In and Line-out.

| Pins | Signals |
|------------|------------------------|
| 1 (Tip) | Line-out (L) |
| 2 (Ring1) | Line-out (R) |
| 3 (Ring2) | GND |
| 4 (Sleeve) | *Mic-in (Passive mic.) |

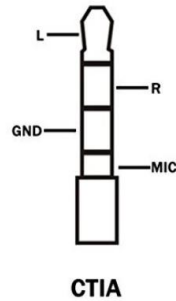

*Mic-in supply passive microphone only, doesn't supply active microphone.

1.8.8 DC-in Phoenix Power Connector (CN13)

The system supports the 18-36 VDC Phoenix DC-in connector for system power input.

| Pins | Signals |
|------|---------|
| 1 | DC+ |
| 2 | DC+ |
| 3 | DC- |
| 4 | DC- |

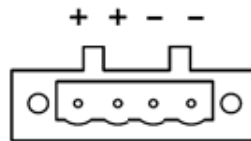

1.8.9 COM Port Connector (COM1)

The system has a serial port: COM1 is RS-232/422/485 port. Please set configuration of the serial port in the Advanced menu in BIOS.

*RS-232/422/485 can be configured via BIOS settings

| Pins | RS-232 | RS-422 | RS-485 |
|------|--------------------------|--------|--------|
| 1 | DCD, Data Carrier Detect | TX- | Data- |
| 2 | RXD, Receive Data | TX+ | Data+ |
| 3 | TXD, Transmit Data | RX+ | No use |
| 4 | DTR, Data Terminal Ready | RX- | No use |
| 5 | GND, Ground | No use | No use |
| 6 | DSR, Data Set Ready | No use | No use |
| 7 | RTS, Request To Send | No use | No use |
| 8 | CTS, Clear To Send | No use | No use |
| 9 | No use | No use | No use |

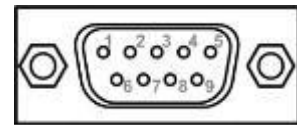

1.8.10 M.2 2280 Key M NVMe SSD (CN5) (Q670E only)

The M.2 2280 Key M NVMe Express SSD for storage.

| Pin | Signal | Pin | Signal | Pin | Signal | Pin | Signal |
|-----|--------------------|-----|--------------------|-----|--------------------|-----|--------------------|
| 1 | GND | 2 | +3.3V | 3 | GND | 4 | +3.3V |
| 5 | PERn3 | 6 | NC | 7 | PERp3 | 8 | NC |
| 9 | GND | 10 | LED_1# | 11 | PETn3 | 12 | +3.3V |
| 13 | PETp3 | 14 | +3.3V | 15 | GND | 16 | +3.3V |
| 17 | PERn2 | 18 | +3.3V | 19 | PERp2 | 20 | NC |
| 21 | GND | 22 | NC | 23 | PETn2 | 24 | NC |
| 25 | PETp2 | 26 | NC | 27 | GND | 28 | NC |
| 29 | PERn1 | 30 | NC | 31 | PERp1 | 32 | NC |
| 33 | GND | 34 | NC | 35 | PETn1 | 36 | NC |
| 37 | PETp1 | 38 | NC | 39 | GND | 40 | NC |
| 41 | PERn0 | 42 | NC | 43 | PERp0 | 44 | NC |
| 45 | GND | 46 | NC | 47 | PETn0 | 48 | NC |
| 49 | PETp0 | 50 | PERST# | 51 | GND | 52 | CLKREQ# |
| 53 | REFCLKn | 54 | PEWAKE# | 55 | REFCLKp | 56 | NC |
| 57 | GND | 58 | NC | 59 | CONNECTOR Key M | 60 | CONNECTOR Key M |
| 61 | CONNECTOR Key M | 62 | CONNECTOR Key M | 63 | CONNECTOR Key M | 64 | CONNECTOR Key M |
| 65 | CONNECTOR Key M | 66 | CONNECTOR Key M | 67 | NC | 68 | NC |
| 69 | NC | 70 | +3.3V | 71 | GND | 72 | +3.3V |
| 73 | GND | 74 | +3.3V | 75 | GND | | |

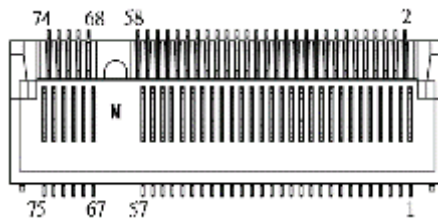

1.8.11 SATA Power Connector (SATAPWR1~2)

The SATA power connector is used for interfacing SATA 2.5" HDD/SSD power supply.

| Pins | Signals |
|------|---------|
| 1 | NC |
| 2 | GND |
| 3 | GND |
| 4 | +5V |

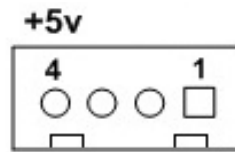

1.8.12 SATA Connector (SATA1~SATA2)

These Serial Advanced Technology Attachment (Serial ATA or SATA) connectors are used as high-speed SATA interfaces. They are computer bus interfaces for connecting to devices such as hard disk drives. This board has two SATA 3.0 ports with 6Gb/s performance.

| Pins | Signals |
|------|----------|
| 1 | GND |
| 2 | SATA_TX+ |
| 3 | SATA_TX- |
| 4 | GND |
| 5 | SATA_RX- |
| 6 | SATA_RX+ |
| 7 | GND |

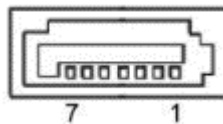

1.8.13 Power On/OFF Button & LED (SW2)

The power button is on the I/O side. It allows users to control IPC96xA power on/off, The LED displays the current status, refer to the table below for information.

| Function | Description |
|----------|--------------------|
| On | Turn on/off system |
| Off | Keep system status |



| Power button LED | Description |
|---------------------------|-------------------------------|
| Orange | System shut down |
| Blue | System power on |
| Blinking 4 times on cycle | Input power under Low Voltage |

| Function | Description |
|---------------|--|
| Program LED 1 | User defined green (On/Off/Blinking)*1 |
| Program LED 2 | User defined green (On/Off/Blinking)*1 |
| Program LED 3 | User defined green (On/Off/Blinking)*1 |
| HDD LED | HDD Read/Write, Green blinking |

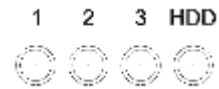

Note: For usage details, please contact the Axiomtek service window

1.8.14 Extended control Connector (CN12)

The system has one 4-pin connector output for extended control function.

| Pins | Signals |
|------|--|
| 1 | GND |
| 2 | PLED Power Out (Driver current Max: +3.3V/20mA) |
| 3 | EX SW Touch to GND : Turn on/off system |
| 4 | IGN (Max: +36V DCin)*1 |

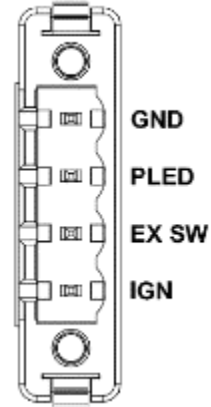

Note. For detailed functions, refer to the IGN chapter

1.8.15 MIO530 Module Kit, M.2 Key B+M.2 Key E (Q670E sku Only)

Key B

| Pin | Signal | Pin | Signal | Pin | Signal | Pin | Signal |
|-----|------------|-----|----------------------|-----|-----------------------|-----|-------------|
| 1 | CONFIG_3 | 2 | +3.3V | 3 | GND | 4 | +3.3V |
| 5 | GND | 6 | Full Card PWR OFF | 7 | USB_D+ | 8 | W_DISABLE1# |
| 9 | USB_D- | 10 | GPIO_9 | 11 | GND | 12 | Key B |
| 13 | Key B | 14 | Key B | 15 | Key B | 16 | Key B |
| 17 | Key B | 18 | Key B | 19 | Key B | 20 | GPIO_5 |
| 21 | CONFIG_0 | 22 | GPIO_6 | 23 | GPIO_11 | 24 | GPIO_7 |
| 25 | DPR | 26 | GPIO_10 | 27 | GND | 28 | GPIO_8 |
| 29 | USB3.1-Tx- | 30 | UIM-RESET | 31 | USB3.1-Tx+ | 32 | UIM-CLK (O) |
| 33 | GND | 34 | UIM-DATA (I/O) | 35 | USB3.1-Rx- | 36 | UIM-PWR (O) |
| 37 | USB3.1-Rx+ | 38 | NC | 39 | GND | 40 | GPIO_0 |
| 41 | PERn0 | 42 | GPIO_1 | 43 | PERp0 | 44 | GPIO_2 |
| 45 | GND | 46 | GPIO_3 | 47 | PETn0 | 48 | GPIO_4 |
| 49 | PETp0 | 50 | PERST# | 51 | GND | 52 | CLKREQ# |
| 53 | REFCLKn | 54 | PEWAKE# | 55 | REFCLKp | 56 | NC |
| 57 | GND | 58 | NC | 59 | ANTCTL0 | 60 | COEX3 |
| 61 | ANTCTL1 | 62 | COEX_RXD | 63 | ANTCTL2 | 64 | COEX_TXD |
| 65 | ANTCTL3 | 66 | SIM_DETECT | 67 | RESET# (I)(0/1.8V) | 68 | SUSCLK |
| 69 | CONFIG_1 | 70 | +3.3V | 71 | GND | 72 | +3.3V |
| 73 | GND | 74 | +3.3V | 75 | CONFIG_2 | | |



Key E

| Pin | Signal | Pin | Signal | Pin | Signal | Pin | Signal |
|-----|-----------------|-----|-----------------|-----|-----------------|-----|-----------------|
| 1 | GND | 2 | +3.3V | 3 | USB_D+ | 4 | +3.3V |
| 5 | USB_D- | 6 | NC | 7 | GND | 8 | NC |
| 9 | NC | 10 | NC | 11 | NC | 12 | NC |
| 13 | NC | 14 | NC | 15 | NC | 16 | NC |
| 17 | NC | 18 | GND | 19 | NC | 20 | NC |
| 21 | NC | 22 | NC | 23 | NC | 24 | CONNECTOR KEY E |
| 25 | CONNECTOR KEY E | 26 | CONNECTOR KEY E | 27 | CONNECTOR KEY E | 28 | CONNECTOR KEY E |
| 29 | CONNECTOR KEY E | 30 | CONNECTOR KEY E | 31 | CONNECTOR KEY E | 32 | NC |
| 33 | GND | 34 | NC | 35 | PETp0 | 36 | NC |
| 37 | PETn0 | 38 | NC | 39 | GND | 40 | NC |
| 41 | PERp0 | 42 | NC | 43 | PERn0 | 44 | NC |
| 45 | GND | 46 | NC | 47 | REFCLKp0 | 48 | NC |
| 49 | REFCLKn0 | 50 | SUSCLK | 51 | GND | 52 | PERST0# |
| 53 | CLKREQ0# | 54 | W_DISABLE2# | 55 | PEWAKE0# | 56 | W_DISABLE1# |
| 57 | GND | 58 | I2C_DATA | 59 | NC | 60 | I2C_CLK |
| 61 | NC | 62 | ALERT# | 63 | GND | 64 | NC |
| 65 | NC | 66 | NC | 67 | NC | 68 | NC |
| 69 | GND | 70 | NC | 71 | NC | 72 | +3.3V |
| 73 | NC | 74 | +3.3V | 75 | GND | | |

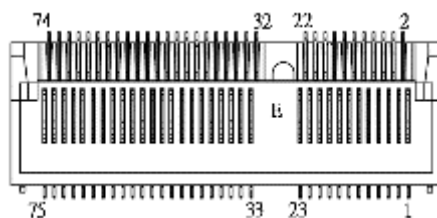

1.8.16 Flexible IO - AX93511

The system has an optional four serial port module. COM1~COM4 are RS-232/422/485 ports. Please refer to Chapter 3 for the details of BIOS setting.

*RS-232/422/485 can be configured via BIOS settings

※COM2,COM3,COM4,COM5

| Pins | RS-232 | RS-422 | RS-485 |
|------|--------------------------|--------|--------|
| 1 | DCD, Data Carrier Detect | TX- | Data- |
| 2 | RXD, Receive Data | TX+ | Data+ |
| 3 | TXD, Transmit Data | RX+ | No use |
| 4 | DTR, Data Terminal Ready | RX- | No use |
| 5 | GND, Ground | No use | No use |
| 6 | DSR, Data Set Ready | No use | No use |
| 7 | RTS, Request to Send | No use | No use |
| 8 | CTS, Clear to Send | No use | No use |
| 9 | RI, Ring Indicator | No use | No use |

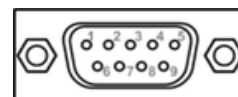

1.8.17 Flexible IO - AX93512

The system has an optional module which comes equipped two serial ports and DIO ports.

COM1~COM2 are RS-232/422/485 with isolated 1.5KVDC protection and DIO1~DIO2 8-in/8-out isolated 1.5KVDC DIO ports.

*RS-232/422/485 can be configured via BIOS settings

※COM2,COM3,DIO1,DIO2

| Pins | RS-232 | RS-422 | RS-485 |
|------|--------------------------|--------|--------|
| 1 | DCD, Data Carrier Detect | TX- | Data- |
| 2 | RXD, Receive Data | TX+ | Data+ |
| 3 | TXD, Transmit Data | RX+ | No use |
| 4 | DTR, Data Terminal Ready | RX- | No use |
| 5 | GND, Ground | No use | No use |
| 6 | DSR, Data Set Ready | No use | No use |
| 7 | RTS, Request to Send | No use | No use |
| 8 | CTS, Clear to Send | No use | No use |
| 9 | RI, Ring Indicator | No use | No use |
| 10 | GND_EARTH | No use | No use |

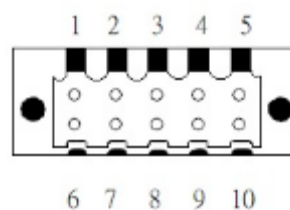

- Digital I/O Specification (per port)



Note: The RS-485 only support below communicate data format:

8 data bits + 1 stop bit

8 data bits + 1 parity bit + 1 stop bit

8 data bits + 1 parity bit + 2 stop bits

8 data bits + 2 stop bits

7 data bits + 1 parity bit (even or odd) + 2 stop bits

| DIO1 | | DIO2 | |
|------|-----------------|------|-----------------|
| Pin | Function | Pin | Function |
| 1 | Common1 PWR+ | 1 | Common2 PWR+ |
| 2 | DO10 | 2 | DO20 |
| 3 | DO11 | 3 | DO21 |
| 4 | DO12 | 4 | DO22 |
| 5 | DO13 | 5 | DO23 |
| 6 | Common1 PWR- | 6 | Common2 PWR- |
| 7 | External1 Power | 7 | External2 Power |
| 8 | DI10 | 8 | DI20 |
| 9 | DI11 | 9 | DI21 |
| 10 | DI12 | 10 | DI22 |
| 11 | DI13 | 11 | DI23 |
| 12 | Isolation1 GND | 12 | Isolation2 GND |

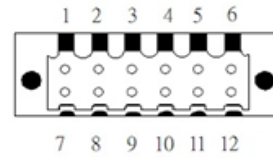

Isolated Digital Input

The diagram shows how to connect external input sources and systems.

Each isolated digital input channel accepts 0~30 VDC.

DI DRY Contact

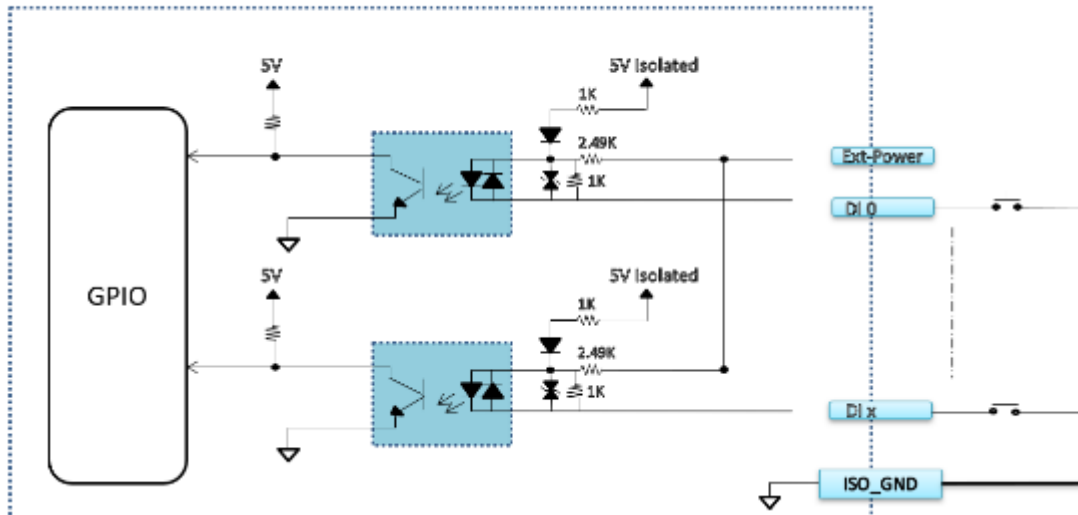

DI WET contact

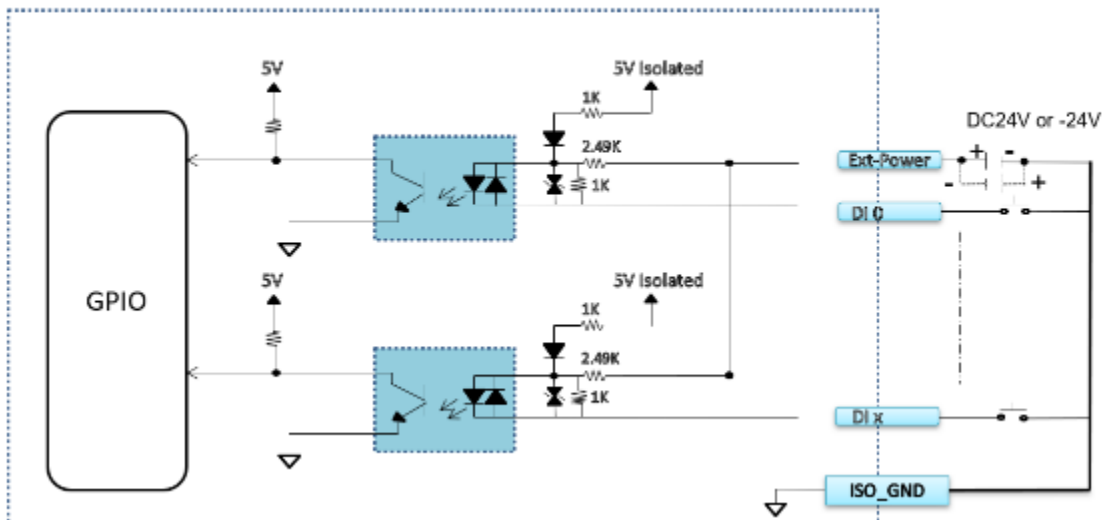

Isolated Digital Output

The figure shows how to connect between an output channel and the system.

If an external voltage Max +30VDC is applied to an isolated output channel, the current will flow from the external voltage source to the system.

Please note that the current through each DO channel should not exceed 200 mA.

Digital Output (Sink type)

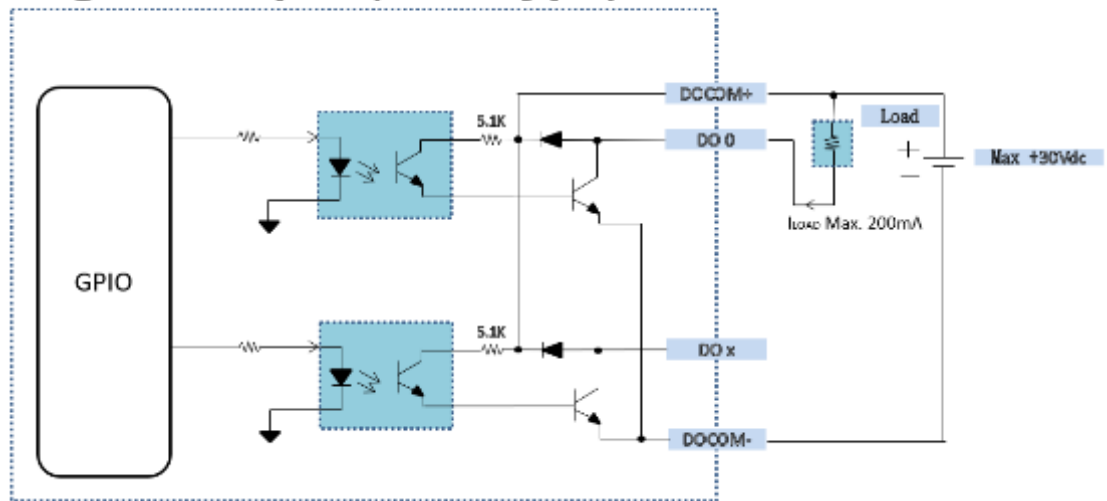

1.8.18 Flexible IO – AX93516

The system has an optional four serial ports module. COM1~COM4 are RS-232/422/485 with 2KVDC isolation protection. Please refer to Chapter 4 for the details of BIOS setting.

※COM2,COM3,COM4,COM5

*RS-232/422/485 can be configured via BIOS settings

| Pins | RS-232 | RS-422 | RS-485 |
|------|--------------------------|--------|--------|
| 1 | DCD, Data Carrier Detect | TX- | Data- |
| 2 | RXD, Receive Data | TX+ | Data+ |
| 3 | TXD, Transmit Data | RX+ | No use |
| 4 | DTR, Data Terminal Ready | RX- | No use |
| 5 | GND, Ground | No use | No use |
| 6 | DSR, Data Set Ready | No use | No use |
| 7 | RTS, Request to Send | No use | No use |
| 8 | CTS, Clear to Send | No use | No use |
| 9 | RI, Ring Indicator | No use | No use |
| 10 | GND_EARTH | No use | No use |

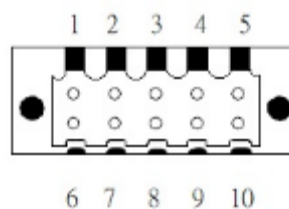

Digital I/O Specification (per port)



Note: The RS-485 only support below communicate data format:

- 8 data bits + 1 stop bit
- 8 data bits + 1 parity bit + 1 stop bit
- 8 data bits + 1 parity bit + 2 stop bits
- 8 data bits + 2 stop bits
- 7 data bits + 1 parity bit (even or odd) + 2 stop bits

1.8.19 Flexible IO – AX93519

The system has an optional two serial ports module. 2 RS-232/422/485, 2 USB and one LAN. Please refer to Chapter 4 for the details of BIOS setting.

※COM2,COM3

*RS-232/422/485 can be configured via BIOS settings

| Pins | RS-232 | RS-422 | RS-485 |
|------|--------------------------|--------|--------|
| 1 | DCD, Data Carrier Detect | TX- | Data- |
| 2 | RXD, Receive Data | TX+ | Data+ |
| 3 | TXD, Transmit Data | RX+ | No use |
| 4 | DTR, Data Terminal Ready | RX- | No use |
| 5 | GND, Ground | No use | No use |
| 6 | DSR, Data Set Ready | No use | No use |
| 7 | RTS, Request To Send | No use | No use |
| 8 | CTS, Clear To Send | No use | No use |
| 9 | RI, Ring Indicator | No use | No use |

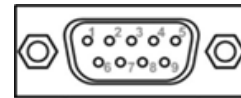

| Pins | Signal USB Port 0 | Pins | Signal USB Port 1 |
|------|-----------------------------------|------|-----------------------------------|
| 1 | USB_VCC (+5V level standby power) | 1 | USB_VCC (+5V level standby power) |
| 2 | USB_Data2- | 2 | USB_Data3- |
| 3 | USB_Data2+ | 3 | USB_Data3+ |
| 4 | GND | 4 | GND |
| 5 | SSRX2- | 5 | SSRX3- |
| 6 | SSRX2+ | 6 | SSRX3+ |
| 7 | GND | 7 | GND |
| 8 | SSTX2- | 8 | SSTX3- |
| 9 | SSTX2+ | 9 | SSTX3+ |



| Pins | 1000 Base-T | 100/10 Base-T | Descriptions |
|------|--|------------------|---------------------------------|
| L1 | BI_DA+ | TX+ | Bidirectional or Transmit Data+ |
| L2 | BI_DA- | TX- | Bidirectional or Transmit Data- |
| L3 | BI_DB+ | RX+ | Bidirectional or Receive Data+ |
| L4 | BI_DC+ | N.C. | Bidirectional or Not Connected |
| L5 | BI_DC- | N.C. | Bidirectional or Not Connected |
| L6 | BI_DB- | RX- | Bidirectional or Receive Data- |
| L7 | BI_DD+ | N.C. | Bidirectional or Not Connected |
| L8 | BI_DD- | N.C. | Bidirectional or Not Connected |
| A | Active Link LED (Yellow) Off: No link Blinking: Data activity detected | | |
| B | Speed LED 1000: Orange 100: Green 10: OFF | | |

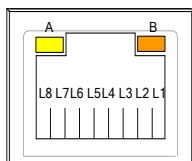

1.8.20 Flexible IO – MIO160

The system has an optional module to support six serial port (4-wire RS-232: TX/RX/RTS/CTS)/422/485 isolated 1.5kVDC and two CAN bus with isolated 1.5kVDC (CAN 2.0A and CAN2.0B protocol).. Please refer to Chapter 4 for the details of BIOS setting.

※COM2,COM3,COM4,COM5, COM6, COM7

※CAN1, CAN2

*RS-232/422/485 can be configured via BIOS settings

Supports High-Speed Mode 115.2 Kbps, up to 1.5 Kbps

| CN1 (COM2 ~ COM7) | | | |
|-------------------|----------------------|-------------|-------------|
| Pins | RS-232 | RS-422 | RS-485 |
| 1 | GND, Ground | GND, Ground | GND, Ground |
| 2 | RTS, Request To Send | RX- | No use |
| 3 | TXD, Transmit Data | RX+ | No use |
| 4 | CTS, Clear To Send | TX- | D- |
| 5 | RXD, Receive Data | TX+ | D+ |
| 6 | GND, Ground | GND, Ground | GND, Ground |
| 7 | RTS, Request to Send | RX- | No use |
| 8 | TXD, Transmit Data | RX+ | No use |
| 9 | CTS, Clear to Send | TX- | D- |
| 10 | RXD, Receive Data | TX+ | D+ |

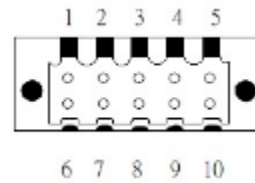

| CN4 (CAN1 & CAN2) | |
|-------------------|-------------|
| Pins | CAN |
| 1 | VCC |
| 2 | CAN-H |
| 3 | CAN-L |
| 4 | GND, Ground |
| 5 | VCC |
| 6 | CAN-H |
| 7 | CAN-L |
| 8 | GND, Ground |

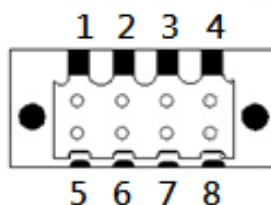

1.8.21 Riser card – EIO121, EIO122, EIO141, EIO142

IPC962A and IPC964A has a riser module to support PCIe and PCI slots.



Note: Please refer to chapter 1.2.3 for the riser specifications.



Note: Please refer to chapter 1.2.3 for the maximum power rating limitation of riser.



Note: 4-pin power connector is reserved for Axiomtek device only.

Fan Connectors (FAN1~FAN2)

This motherboard has three fan connectors. Find fan speed option(s) at BIOS Setup Utility: Advanced HW Monitor PC Health Status.

The FAN1~2 (4x1-Pin P=2.54mm) is for the expansion Slot fan connector.

| Pins | Signals |
|------|---------------------|
| 1 | GND |
| 2 | +12V |
| 3 | FAN Speed Detection |
| 4 | FAN Speed Control |



Expansion Power Input Connectors (ATX1)

This ATX1 connector for reserved uses. (Black color)

| Pins | Signals |
|------|----------------|
| 1 | GND |
| 2 | GND |
| 3 | +24V (By DCIN) |
| 4 | +24V (By DCIN) |

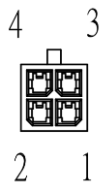

Note: ATX1 is reserved, please contact Axiomtek before using it.

Expansion Power Input Connectors (ATX2 ~ ATX3)

This ATX2~3 connector for slot card uses. (Black color)

| Pins | Signals |
|------|---------|
| 1 | GND |
| 2 | GND |
| 3 | GND |
| 4 | GND |
| 5 | +12V |
| 6 | +12V |
| 7 | +12V |
| 8 | GND |

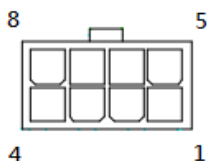

Temperature Sensor Source Select (JP1)

Use these jumpers (3x1-Pin P=2.54mm) to set temperature sensor source to operate external or onboard mode.

Onboard Sensor (Default) 1-2 close

| Function | Setting |
|----------|------------------------|
| 1 | On Board Thermistor |
| 2 | GND |
| 3 | Reserved |



Note: Pin 3 is reserved, please contact Axiomtek before using it.

This page is intentionally left blank.

SECTION 2 HARDWARE INSTALLATION

The IPC960A/IPC962A/IPC964A Series products are convenient for your various hardware configurations, such as CPU (Central Processing Unit), memory module, HDD (Hard Disk Drive) and PCIe/PCI card. Chapter 2 will show you how to install these hardware parts.

2.1 Installing the processor

The Intel® Core™ i9/i7/i5/i3 processors are available as a boxed processor for the IPC960A / IPC962A / IPC964A system. Intel recommends the processors should be installed by a qualified computer professional since this electronic device may cause serious damage to the installer, system and processor if installed improperly.



Note: Before attempting to install a new processor, carefully review the documentation that came with your system and make sure that you will not be voiding your warranty by opening the computer or replacing your processor.

Instructions:

1. Make sure that your system can accommodate the Intel® Core™ i9/i7/i5/i3/Celeron® processor that you want to install. Check for CPU card, BIOS, and thermal compatibility by using the manufacturer's documentation for the system, or by contacting the vendor if necessary. This processor should only be installed in systems supporting the Intel® Core™ i9/i7/i5/i3/Celeron® processors.
2. Obtain access to your processor socket as described in the documentation for your system.
3. If the cooling solution prevents you from accessing the processor socket, you may need to remove it. Instructions on how to remove your cooling solution should be provided in the documentation that came with the system.

2.2 Procedure of Installation

This chapter will guide you on installing a processor.

- Step 1 Turn off the system.
- Step 2 Disconnect the power connector.
- Step 3 Loosen six screws to remove the heatsink cover from the chassis.

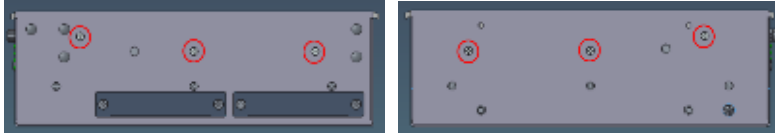

- Step 4 After opening the heatsink cover, you can locate the CPU socket as marked. Align pins of the CPU with the pin holes of the socket. Beware of the CPU's orientation when you align the arrow mark on the CPU with the arrow key on the socket. Remove the Mylar before you install the CPU into the socket.

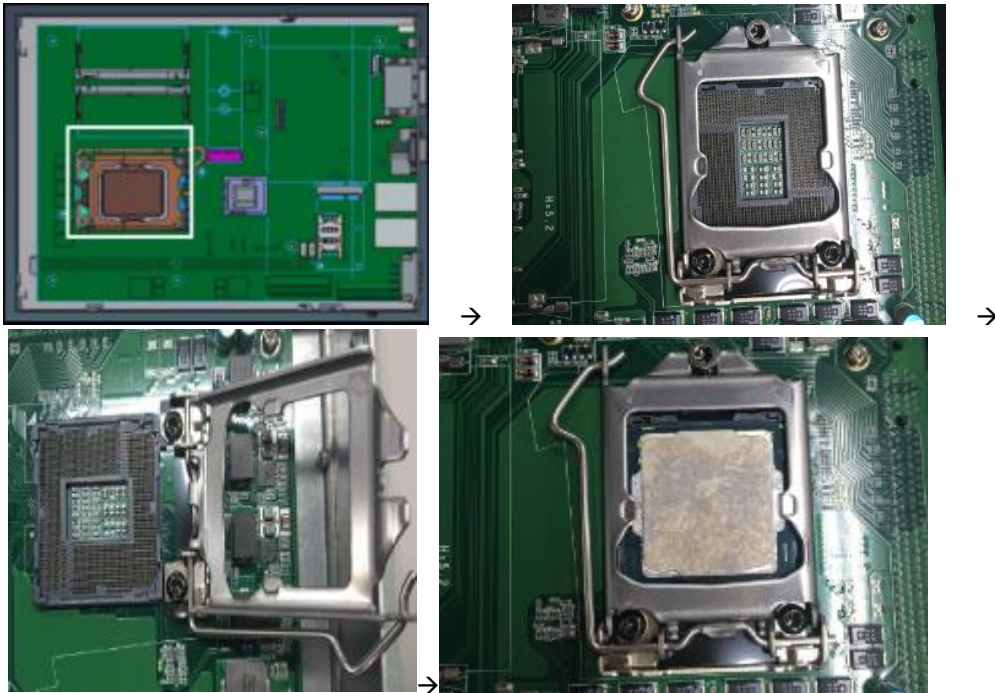

- Step 5 Apply thermal grease on top of the CPU.



- Step 6 After installing all components, close the heatsink cover back to the chassis and fasten all screws.

2.3 Installing the memory module

- Step 1 Paste the thermal pad on the bottom side of the module. Remember to remove the protective film from the thermal pad.
- Step 2 Turn off the system.
- Step 3 Disconnect the power connector.
- Step 4 Loosen screws to remove the heatsink cover from the chassis.

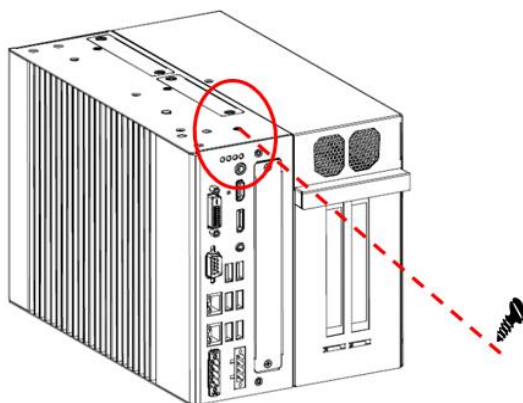

- Step 5 Insert the module to slot and push it down firmly.

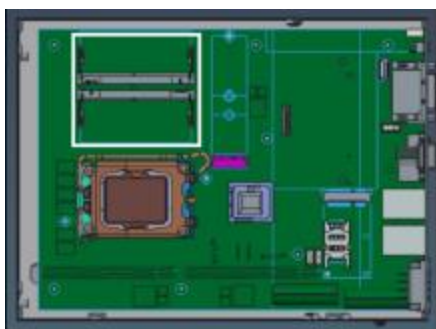

- Step 6 Paste the other thermal pad on the module and then remove the protective film.
- Step 7 Close the heatsink cover back to the chassis and fasten all screws. The installation is complete.

2.4 Installing the hard disk drive

The IPC960A/IPC962A/IPC964A offers two convenient drive bay modules for users to install HDD/SSD. The system offers users two 2.5" Hard Disk Drives for installation. Please follow the steps to install:

- Step 1 Turn off the system.
- Step 2 Disconnect the power connector.
- Step 3 Unscrew 2 screws for each HDD tray and separating the HDD tray from the chassis.

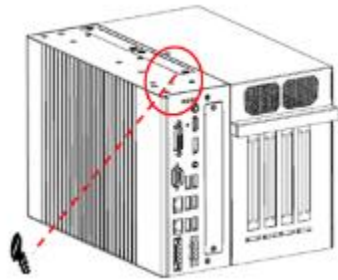

- Step 4 Fix HDD/SSD to the HDD tray with four screws

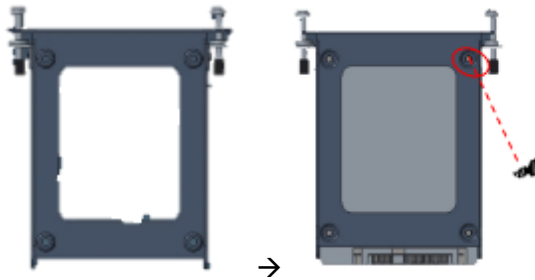

- Step 5 Insert HDD tray to main box, then screw 2 screws for each HDD tray. Installation is complete.

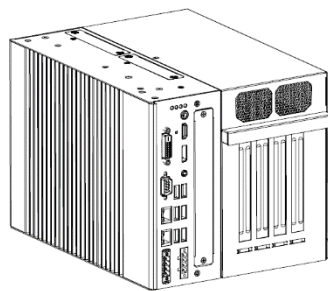

2.5 Installing the extension I/O module

The IPC960A/IPC962A/IPC964A provides an optional extension I/O module for expansion purposes. The procedures of installing the extension I/O module into system is instructed below.

Step 1 Turn off the system.

Step 2 Disconnect the power connector.

Step 3 Loosen screws and separate the cover from the chassis.

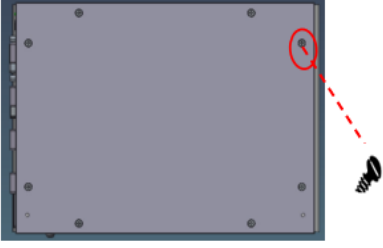
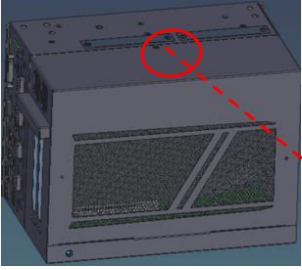
| IPC960A | IPC962A | IPC964A |
|--|---|---------|
|  <p data-bbox="252 931 663 1001">Loosen eight screws and separate the cover from the chassis.</p> |  <p data-bbox="687 931 1339 1001">Loosen one screw and separating the cover from the expansion box.</p> | |

Step 4 Remove the expansion box as shown below.

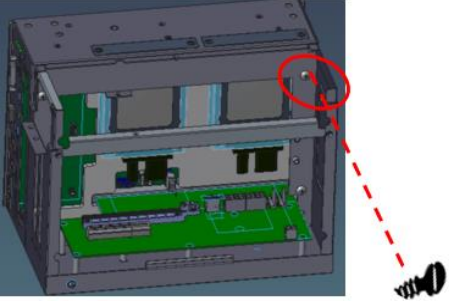
| IPC960A | IPC962A | IPC964A |
|--|--|---------|
| <p data-bbox="252 1205 304 1238">N/A</p> |  <p data-bbox="679 1469 1339 1536">Loosen four screws and separating expansion box from the chassis.</p> | |

Step 5 Remove the blank I/O bracket as shown below.

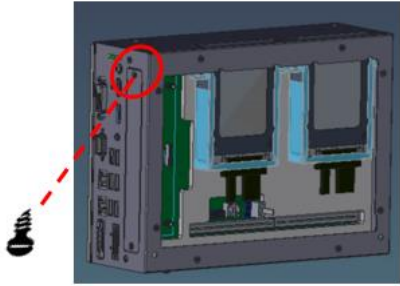
| IPC960A | IPC962A | IPC964A |
|---|---------|---------|
|  <p data-bbox="384 689 1169 719">Loosen two screws and move the blank I/O bracket for the chassis.</p> | | |

Step 6 Plug the extension I/O module into the slot as shown below.

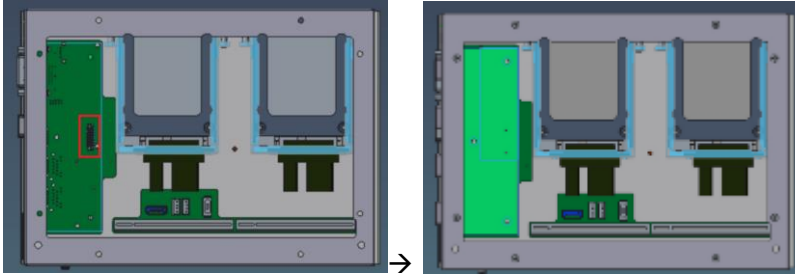
| IPC960A | IPC962A | IPC964A |
|--|---------|---------|
|  <p data-bbox="277 1160 1342 1189">Align the I/O module with the slot, press the module into the slot until it is firmly seated..</p> | | |

Step 7 Screw the extension I/O bracket into system as shown below.

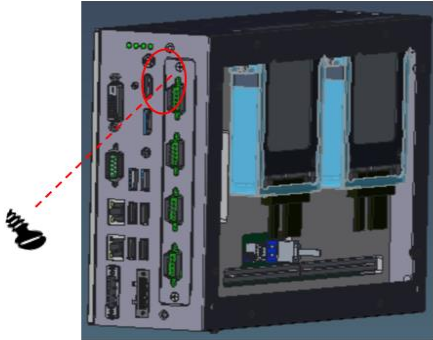
| IPC960A | IPC962A | IPC964A |
|---|---------|---------|
|  <p data-bbox="491 1715 1192 1744">Tighten the two screws to fix the I/O bracket to the chassis.</p> | | |

Step 8 Fasten the expansion box to IPC962A and IPC964A as shown below.

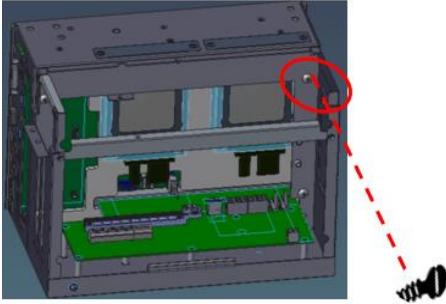
| IPC960A | IPC962A | IPC964A |
|---------|---|---------|
| N/A |  <p data-bbox="678 672 1300 739">Tighten the four screws to fix expansion box with the chassis.</p> | |

Step 9 Fasten system cover. Installation is complete.

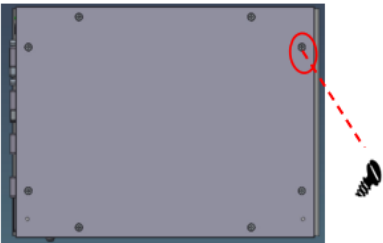
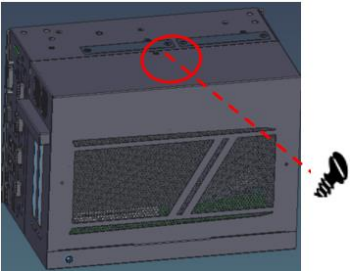
| IPC960A | IPC962A | IPC964A |
|---|---|---------|
|  <p data-bbox="252 1160 646 1232">Put on the cover and tighten the screw. Installation is complete.</p> |  <p data-bbox="686 1176 1340 1243">Put on the cover and tighten the screw. Installation is complete.</p> | |

2.6 Installing the fan module

The IPC962A/IPC964A provides either an internal fan module or an external fan module for optional selection. The procedure of installing the fan module into system is instructed below.

- Step 1 Turn off the system.
- Step 2 Disconnect the power connector.
- Step 3 Loosen the system cover screw and remove the cover from the expansion box.

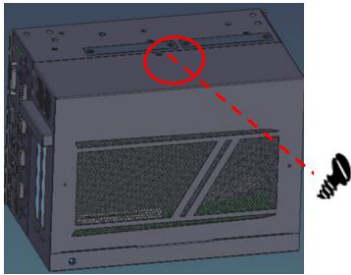

- Step 4 Loosen the screw to remove the bracket.

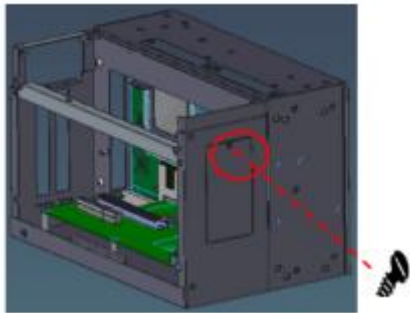

- Step 5 Fasten the fan module into the expansion box.

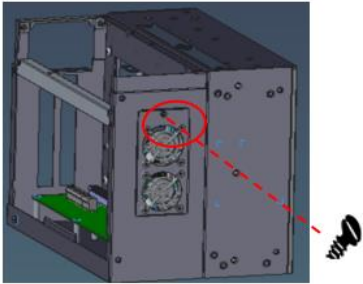
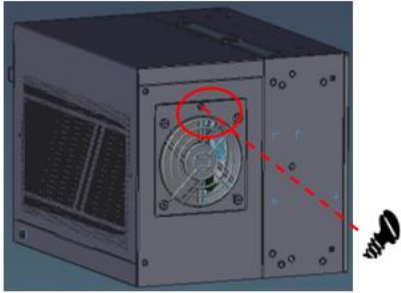
| IPC962A | IPC964A |
|--|--|
|  <p data-bbox="386 1700 815 1774">Tighten a screw to fix the fan module into chassis.</p> |  <p data-bbox="841 1700 1318 1774">Tighten a screw to fix the fan module into chassis.</p> |

Step 6 Plug fan module cable(s) to connector(s).

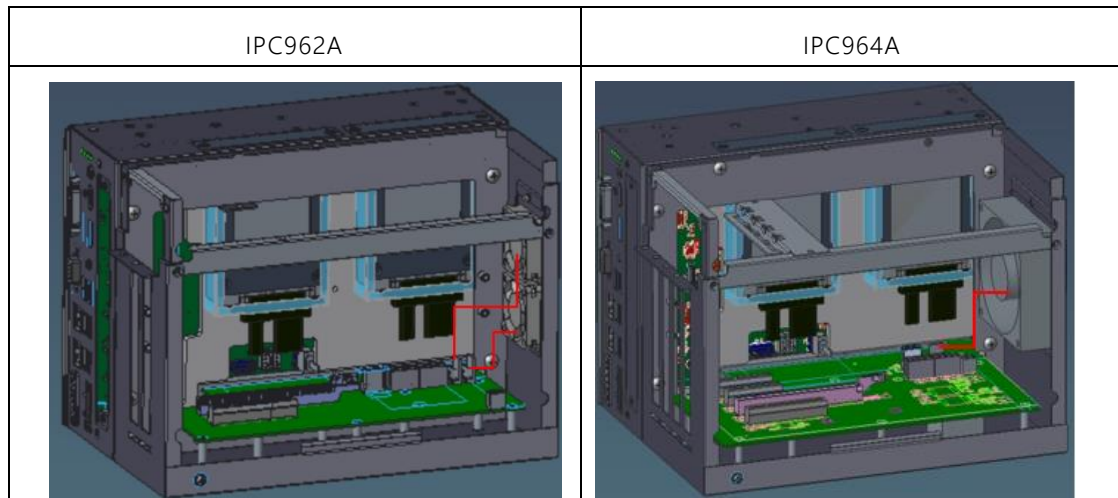

Step 7 After installing the fan module, close the system cover back to the chassis and fasten the screw. Installation is complete.



Note: Reserve at least 25mm space from the rear side for optimal fan air flow.

2.7 Installing PCI or PCIe card

The IPC962A/IPC964A provides two/four PCI or PCIe slots for expansion. The procedure of installing PCI / PCIe expansion cards into system is instructed below.

2.7.1 Installing PCI or PCIe card

Step 1 Turn off the system.

Step 2 Disconnect the power connector.

Step 3 Loosen the system cover screw and remove the cover from the expansion box.

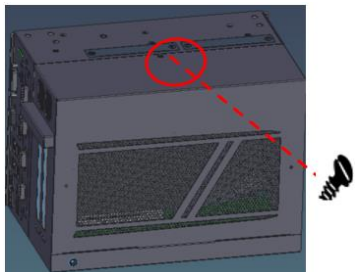

Step 4 Locate the PCI or PCIe slots and remove the slot bracket from the slot in which you want to add the card.

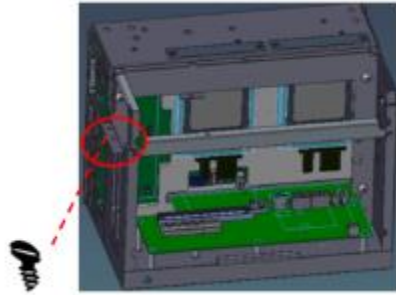

Step 5 Align the PCI or PCIe card with the slot, press the card into the slot until it is firmly seated and screw it. Then, plug the power cable in connector if needed as instructed below in red.

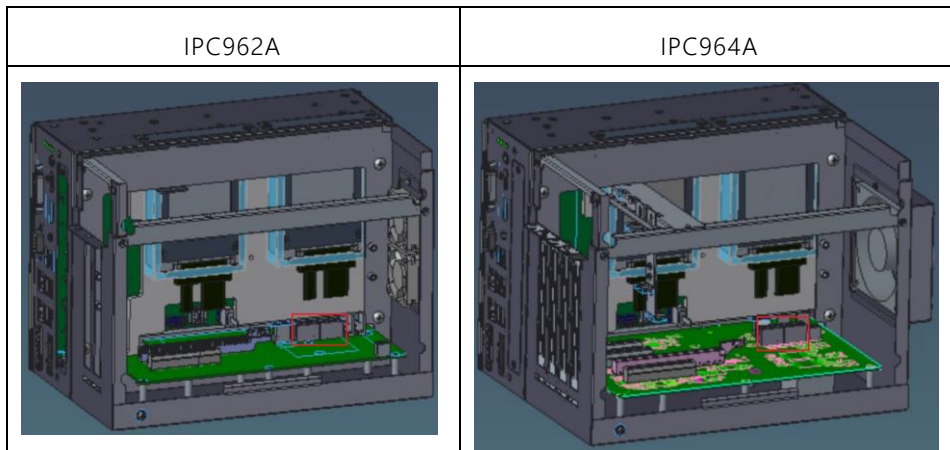

Note: The power cable will be needed when the graphics card power is over 75W.

Step 6 Please take the holder bracket and screws from the accessory box. Fasten the below bracket in chassis with standard height (116.38mm) add-on cards.

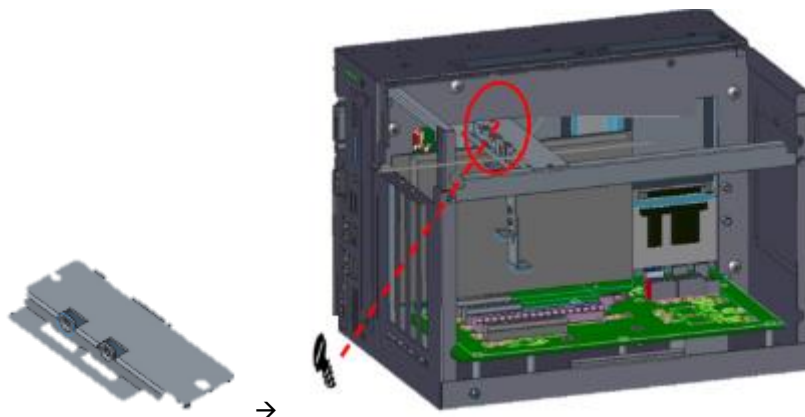

Step 7 IPC962A and IPC964A offer 3 types of extension holder brackets. Please take the brackets and screws from the accessory box and assemble the extension holder bracket. The procedure is illustrated below.



Step 8 Assemble the extension holder bracket, as illustrated below.

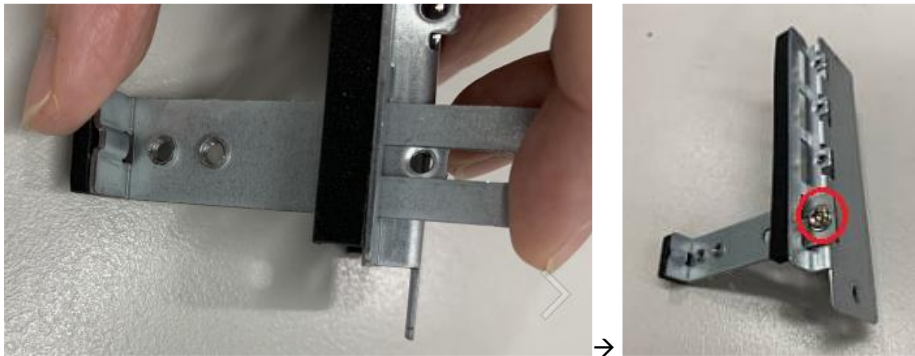

Or

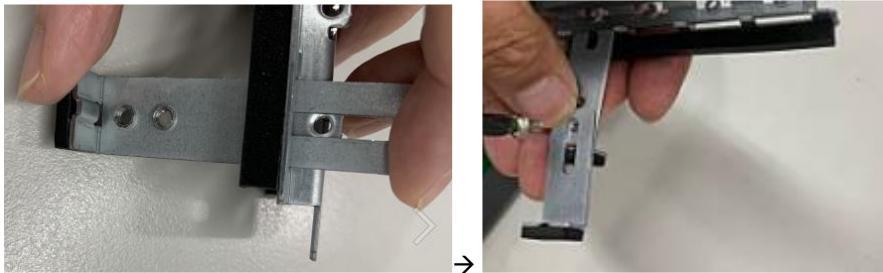

Step 9 Fasten the holder bracket in the chassis, adjust the screw position of the extension bracket to fix the add-on card, and then screw it.



Step 10 Close the cover back to the chassis and tighten the screw. The installation is complete.

2.7.2 The limitation of an add-on card

The following figures show the limitation of an add-in card in different configuration.

IPC962A

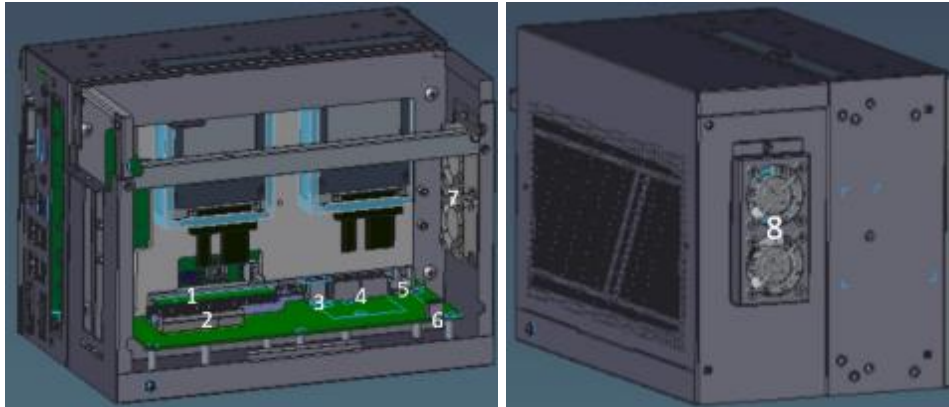

| No. | Description | No. | Description |
|-----|---|-----|-----------------------|
| 1 | Slot 1: PCIe x 16 | 5 | 2 fan connectors |
| 2 | Slot 2: PCIe x8 or PCI | 6 | 4-pin power connector |
| 3 | USB 2.0 type A | 7 | Internal fan module |
| 4 | 2 8-pin power connectors of EIO121 or EIO122 (riser card) | 8 | External fan module |



Note: Please note that below dimension is the maximum length for add-on card with I/O bracket.



Note: Considering heat dissipation potential, a space of 25mm must be left between add-on card and system.



Note: The followings show each slot's max. dimensions for add-in card and its cable routing in the system.

Fan-less or external fan module is installed.

| | Slot 1 (PCIe x16) | Slot 2 (PCIe x4 or PCI) |
|--|----------------------|----------------------------|
| Height (w/ holder bracket) | 46.08-116.38 (mm) | |
| | | |
| Height (w/o holder bracket) | Up to 146.60 (mm) | |
| | | |
| width | 1-slot | 1.5-slot |
| The following shows each slot's max. length for add-in card in the system with different configurations. | | |

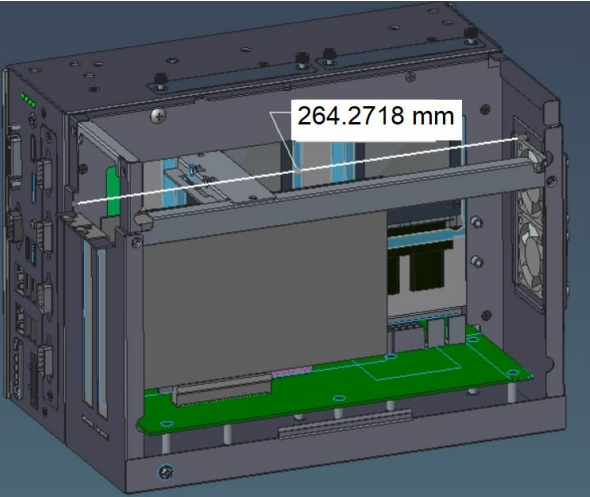
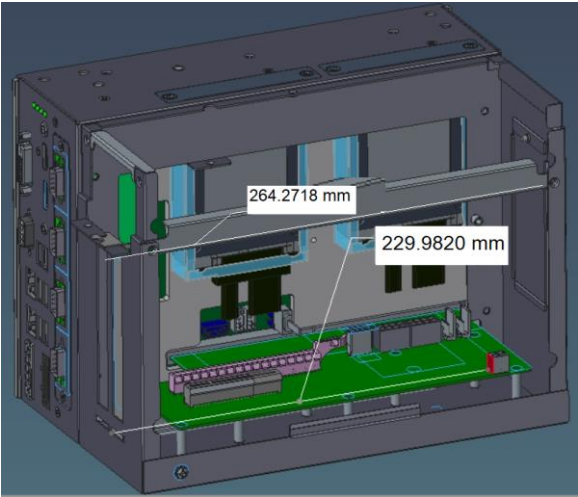
| | | |
|---|---|---------------------------|
| <p>4-pin ATX power cable is un-installed.</p> |  | |
| <p>4-pin ATX power cable is installed.</p> | <p>264.27 (mm)</p> | <p>229.98-264.27 (mm)</p> |
| |  | |

Internal fan module is installed.

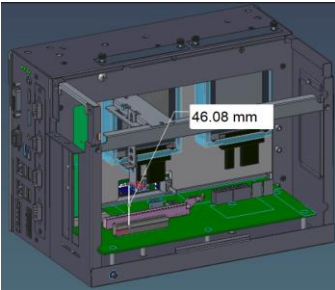
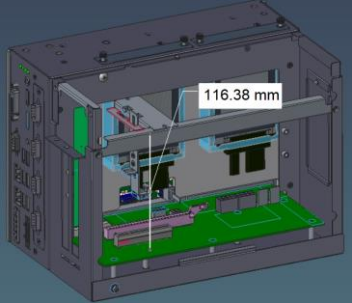
| | <p>Slot 1 (PCIe x16)</p> | <p>Slot 2 (PCIe x4 or PCI)</p> |
|-----------------------------------|---|--|
| <p>Height (w/ holder bracket)</p> | <p>46.08-116.38 (mm)</p> | |
| |  |  |

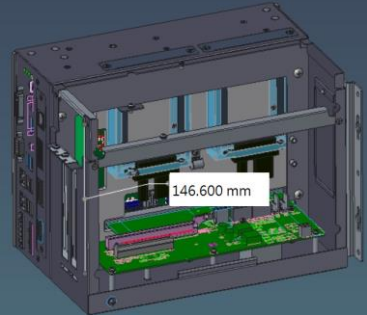
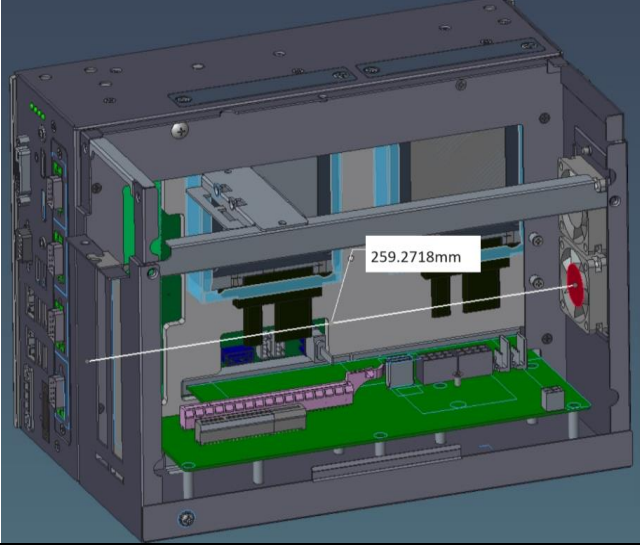
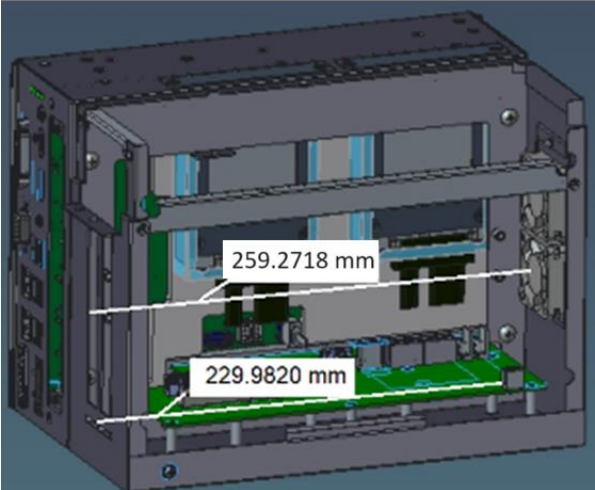
| | | |
|---|---|---------------------------|
| <p>Height (w/o holder bracket)</p> | <p>Up to 146.60 (mm)</p>  | |
| <p>width</p> | <p>1-slot</p> | <p>1.5-slot</p> |
| <p>The following shows each slot's max. length for add-in card in the system with different configurations.</p> | | |
| <p>4-pin ATX power cable is un-installed.</p> | <p>259.27 (mm)</p> | <p>259.27 (mm)</p> |
|  | | |
| <p>4-pin ATX power cable is installed.</p> | <p>259.27 (mm)</p> | <p>229.98-259.27 (mm)</p> |
|  | | |

IPC964A

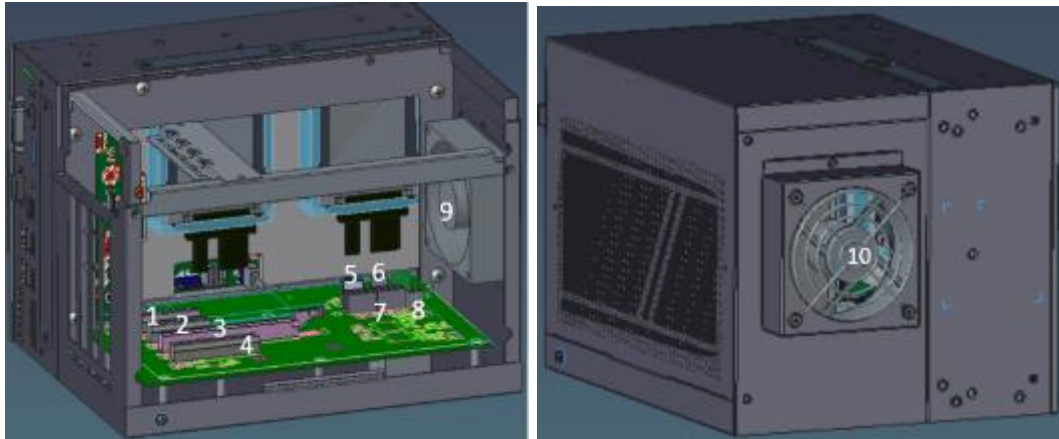

| No. | Description | No. | Description |
|-----|------------------------------------|-----|---|
| 1 | Slot 1: PCIe x 4 | 6 | Fan connector |
| 2 | Slot 2: PCIe x 4 or PCI | 7 | 2 8-pin power connectors of EIO121 or EIO122 (riser card) |
| 3 | Slot 3: PCIe x16 | 8 | 4-pin power connector |
| 4 | Slot 4: PCIe x8 (x4 signal) or PCI | 9 | Internal fan module |
| 5 | USB 2.0 type A | 10 | External fan module |

 Note: Please note that below dimension is the maximum length for add-on card with I/O bracket and power cable routing.

 Note: Considering heat dissipation potential, a space of 25mm must be left between add-on card and system.

Fan-less or external fan module is installed.

| | Slot 1 (PCIe x4) | Slot 2 (PCIe x4 or PCI) | Slot 3 (PCIe x16) | Slot 4 (PCIe x4 or PCI) |
|--|---------------------|----------------------------|----------------------|----------------------------|
| Height (w/ holder bracket) | 46.08-116.38 (mm) | | | |
| | | | | |
| Height (w/o holder bracket) | Up to 146.60 (mm) | | | |
| | | | | |
| width | 1-slot | 1-slot | 1-slot | 1.5-slot |
| The following shows each slot's max. length for add-in card in the system with different configurations. | | | | |
| Riser card power and (or) USB device is (are) un-installed. | 264.27 (mm) | 264.27 (mm) | 264.27 (mm) | 264.27 (mm) |
| | | | | |
| Riser card power | 189.33 (mm) | 264.27 (mm) | 264.27 (mm) | 264.27 (mm) |

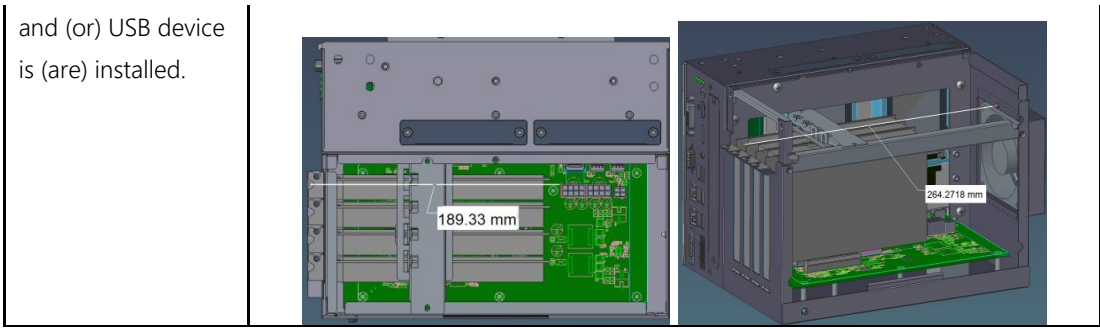

Internal fan module is installed.

| | Slot 1 (PCIe x4) | Slot 2 (PCIe x4 or PCI) | Slot 3 (PCIe x16) | Slot 4 (PCIe x4 or PCI) |
|--|---------------------|----------------------------|----------------------|----------------------------|
| Height (w/ holder bracket) | 46.08-116.38 (mm) | | | |
| | | | | |
| Height (w/o holder bracket) | Up to 146.60 (mm) | | | |
| | | | | |
| width | 1-slot | 1-slot | 1-slot | 1.5-slot |
| The following shows each slot's max. length for add-in card in the system with different configurations. | | | | |
| Riser card power | 244.27 (mm) | 244.27 (mm) | 244.27 (mm) | 244.27 (mm) |

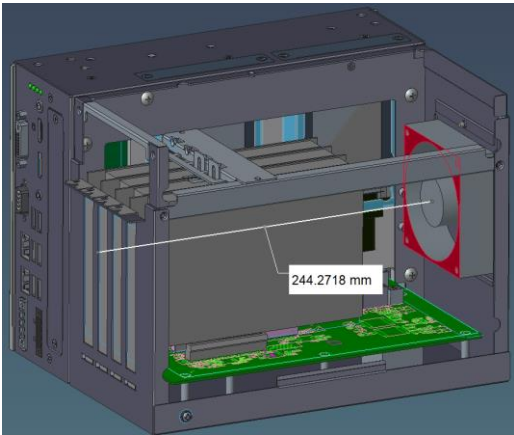
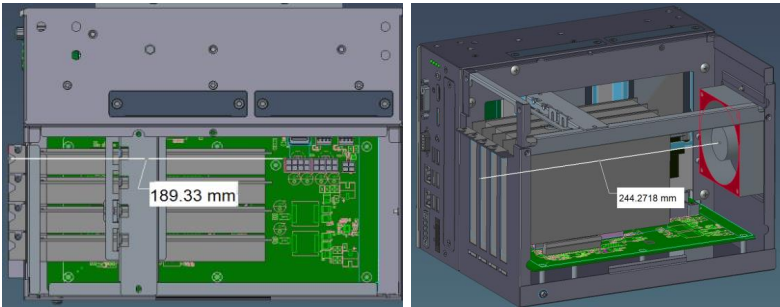
| | | | | |
|---|---|--------------------|--------------------|--------------------|
| <p>and (or) USB device is (are) un-installed.</p> |  | | | |
| <p>Riser card power and (or) USB device is (are) installed.</p> | <p>189.33 (mm)</p> | <p>244.27 (mm)</p> | <p>244.27 (mm)</p> | <p>244.27 (mm)</p> |
| |  | | | |

2.8 Installing the mini card module

The IPC960A, IPC962A and IPC964A come equipped with a mini card slot for users to install a wireless LAN card. Please refer to the following instructions and illustrations for the installation of the wireless LAN.

- Step 1 Please take the wireless LAN card and external antenna(s) from the accessory box.
- Step 2 Turn off the system.
- Step 3 Disconnect the power connector.
- Step 4 Loosen six screws to remove the heatsink cover from the chassis.

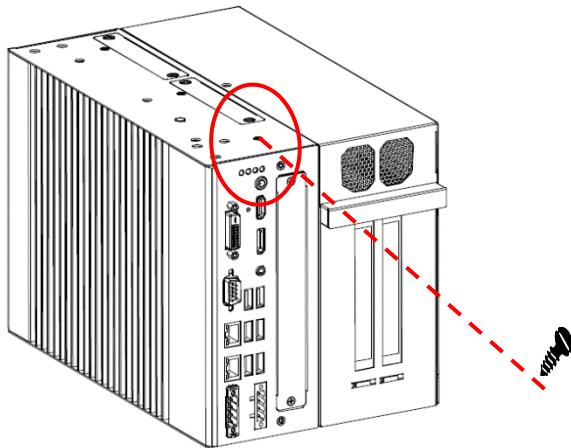

- Step 5 Insert the wireless LAN card into the slot and push it down firmly, install the card tightly to the mainboard, and then plug internal wireless cable(s) into wireless LAN card.

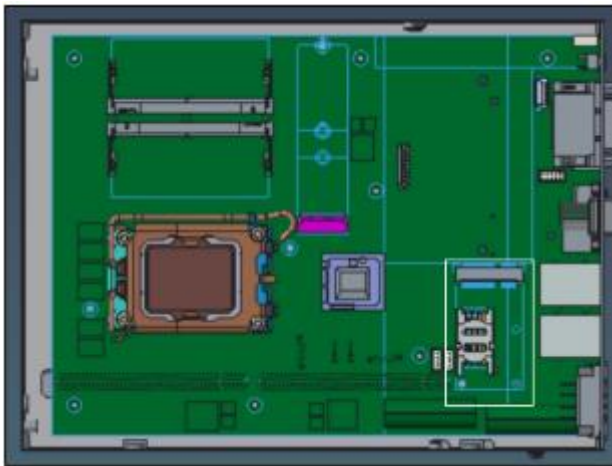

- Step 6 Remove the antenna plug(s), and then screw the antenna(s) on the system.



Step 7 Close the heatsink cover to the chassis and fasten all screws. The installation is complete.



Note: Please use an extended bracket when using a half-size Mini card



Note: There are five antenna holes in the system, please adjust the antenna placement according to the environment.

2.9 Installing the 5G Wireless Module

The IPC960A, IPC962A and IPC964A come with an optional M.2 Key B 3042/3050/3052 slot via MIO530 daughter board for users to install a 5G wireless card. Please refer to the following instructions and illustrations for the installation of the 5G wireless module.

Step 1 Please take the 5G module kit from the accessory box.



Step 2 Paste the thermal pads on the bottom(B) and top side(A) of the module, remember to remove the protective films from the thermal pads.

Step 3 Turn off the system.

Step 4 Disconnect the power connector.

Step 5 Loosen screws to remove the heatsink cover from the chassis.

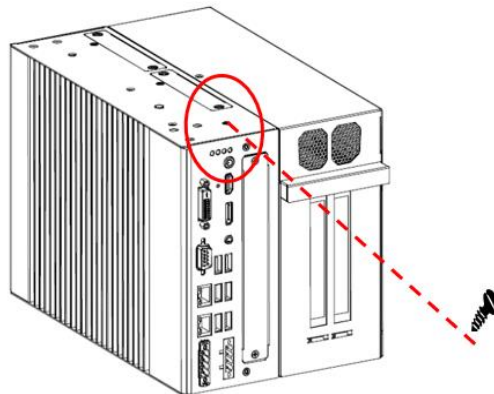

Step 6 Insert the MIO530 board to socket, then insert 5G wireless module into the slot and push it down firmly, tighten the card securely to the mainboard, and then plug the internal 5G internal wireless cables into module. Insert SIM card into SIM slot.

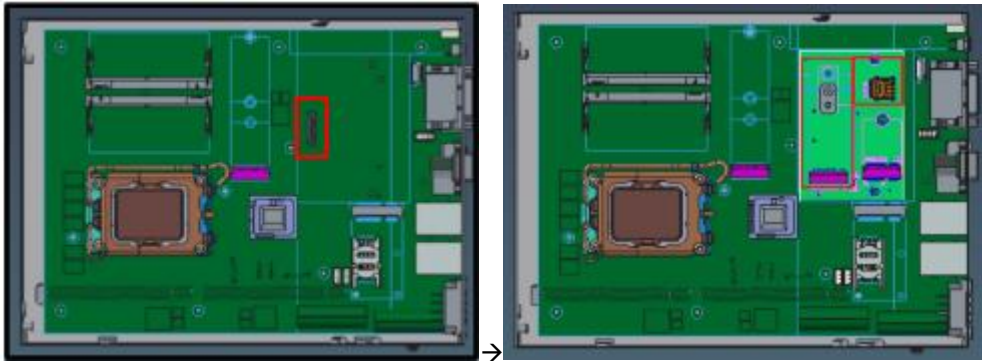

Step 7 Remove the antenna plugs from the top of the system, and install the external antennas.

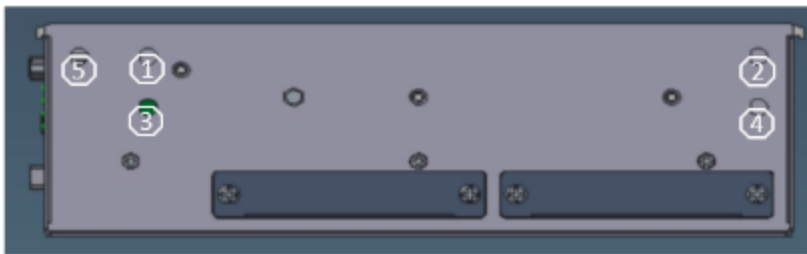

Step 8 Close the heatsink cover to the chassis and fasten all screws. The installation is complete.



Note: Only Q670E platforms can support an M.2 Key B slot.



Note: The thermal solution might be changed due to the different 5G module installed.



Note: There are five antenna holes on the system, please adjust the antenna placement accordingly.

2.10 Installing the M.2 key E wireless module

The IPC960A, IPC962A and IPC964A come equipped with an optional M.2 Key E 2232 slot via MIO530 daughter board for users to install a wireless LAN card. Please refer to the following instructions and illustrations for the installation of the wireless LAN.

- Step 1 Please take the wireless LAN card and external antenna(s) from the accessory box.
- Step 2 Turn off the system.
- Step 3 Disconnect the power connector.
- Step 4 Loosen six screws to remove the heatsink cover from the chassis.

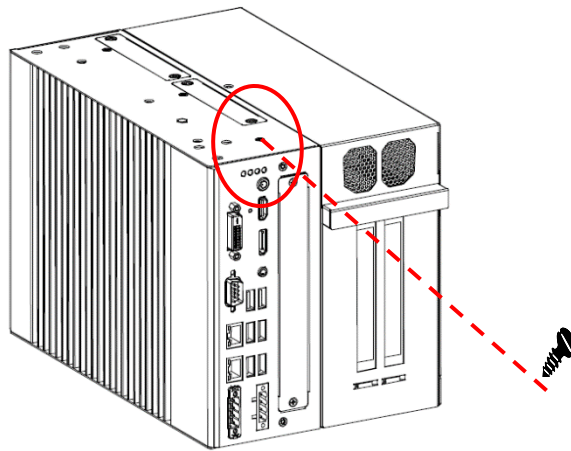

- Step 5 Insert the MIO530 board to socket, then insert wireless LAN module into the slot and push it down firmly, install the card securely to the mainboard, and then plug the internal 5G internal wireless cables into module.

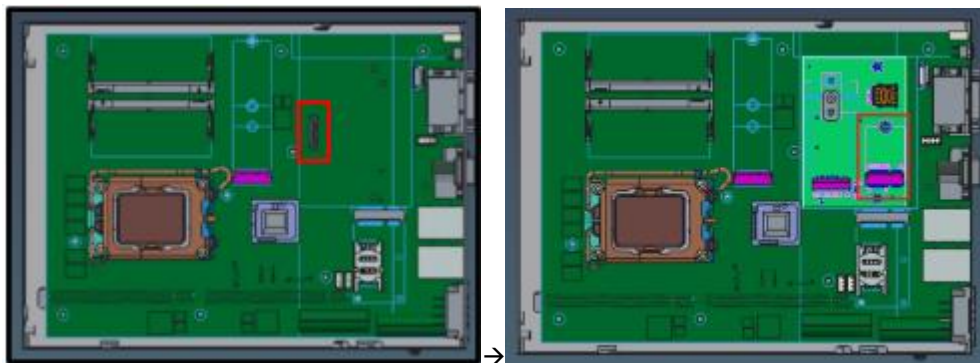

- Step 6 Remove the antenna plug(s), and then screw the antenna(s) on the system.



Step 7 Close the heatsink cover to the chassis and fasten all screws. The installation is complete.



Note: There are five antenna holes in the system, please adjust the antenna placement according to the environment.

2.11 Installing the NVMe SSD module

The IPC960A, IPC962A and IPC964A come equipped with an M.2 Key M 2280 socket (PCIe Gen4 x4) for users to install an NVMe SSD module. Please refer to the following instructions and illustrations for the installation of the NVMe SSD module.

Step 1 Paste the thermal pads on the bottom(B) and top side(A) of the module, remember to remove the protective films from the thermal pads.

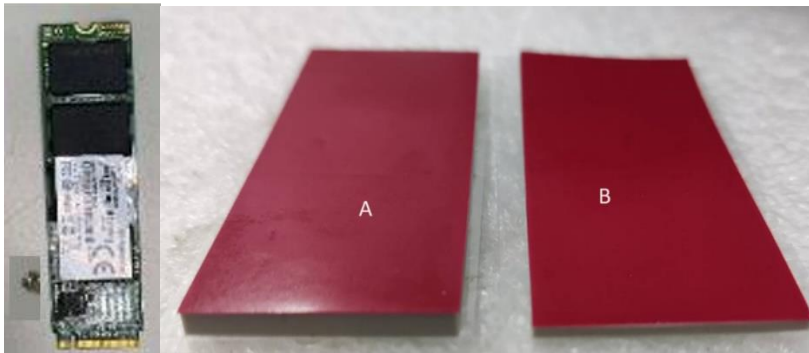

Step 2 Turn off the system.

Step 3 Disconnect the power connector.

Step 4 Loosen screws to remove the heatsink cover from the chassis.

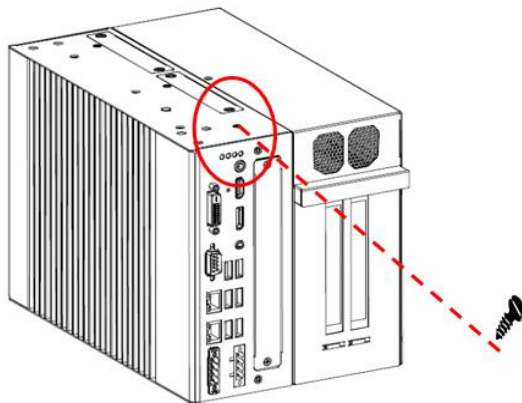

- Step 5 Insert the SSD card to slot and push it down firmly. Then fasten the card tightly to the mainboard.

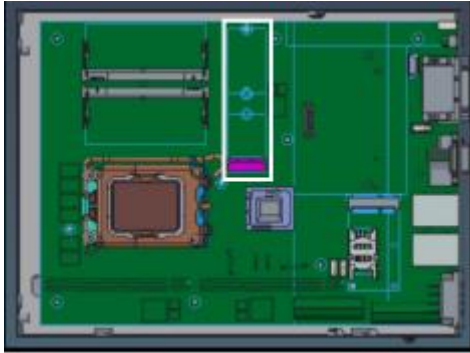

- Step 6 Paste the other thermal pad on the module and then remove the protective film.
- Step 7 Close the heatsink cover back to the chassis and tighten all screws. The installation is complete.

2.12 Mounting

The IPC960A/IPC962A/IPC964A provides versatile mount kits for optional selection.

DIN rail mount

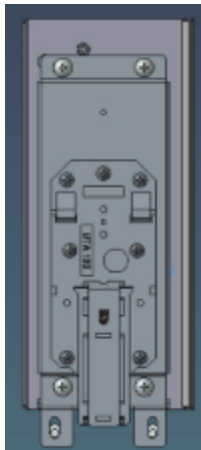

Note: The DIN rail kit can be installed in IPC960A system only.

Bookshelf mount





Note: The bookshelf mount kit can be installed in IPC960A system only.

Wall mount

(1)

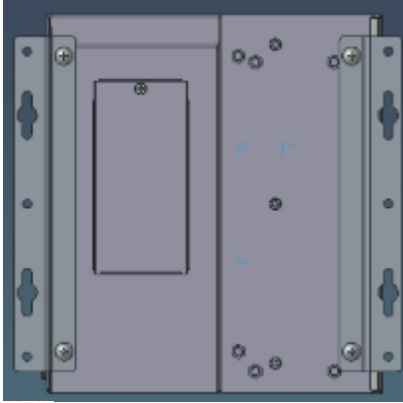

Note: When using this wall mounting (1) in IPC with internal fan module, considering fan air flow, a space must be left between system and wall.



Note: IPC can't support this wall mounting (1) when using external fan module.

(2)

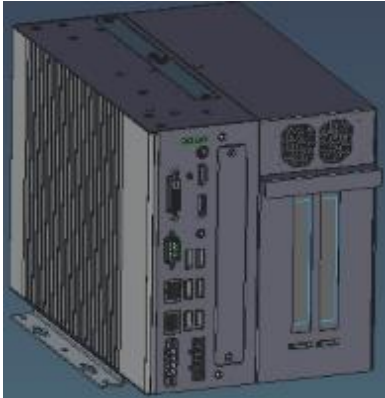

Note: The IPC960A supports any of DIN rail kit, bookshelf mount kit or wall mount kit.

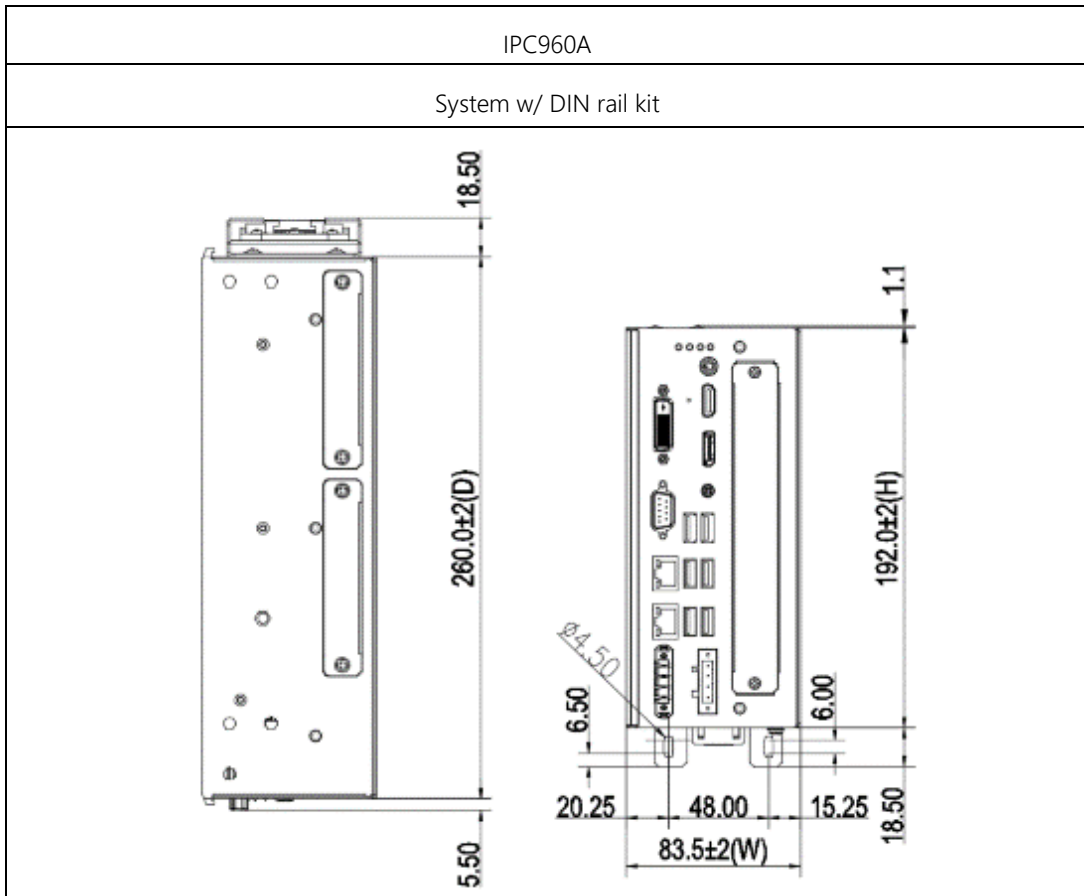

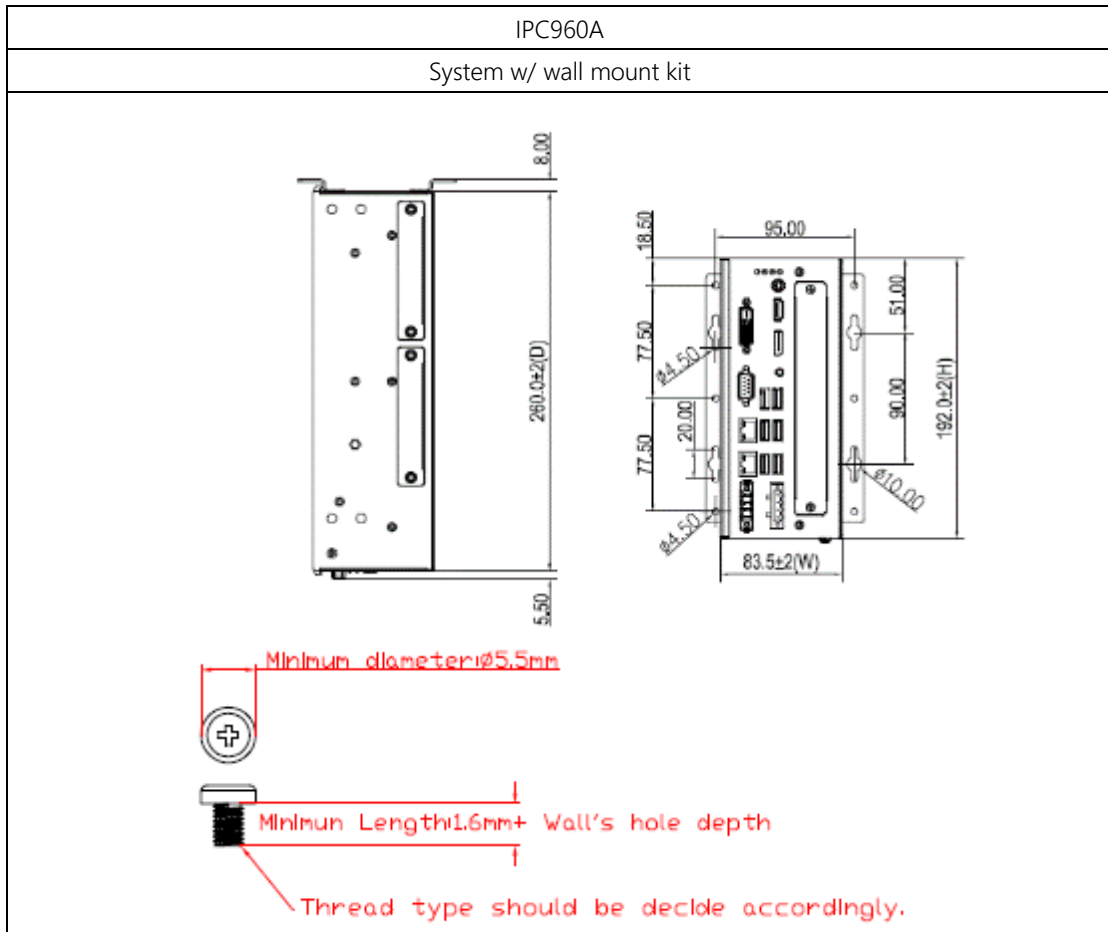
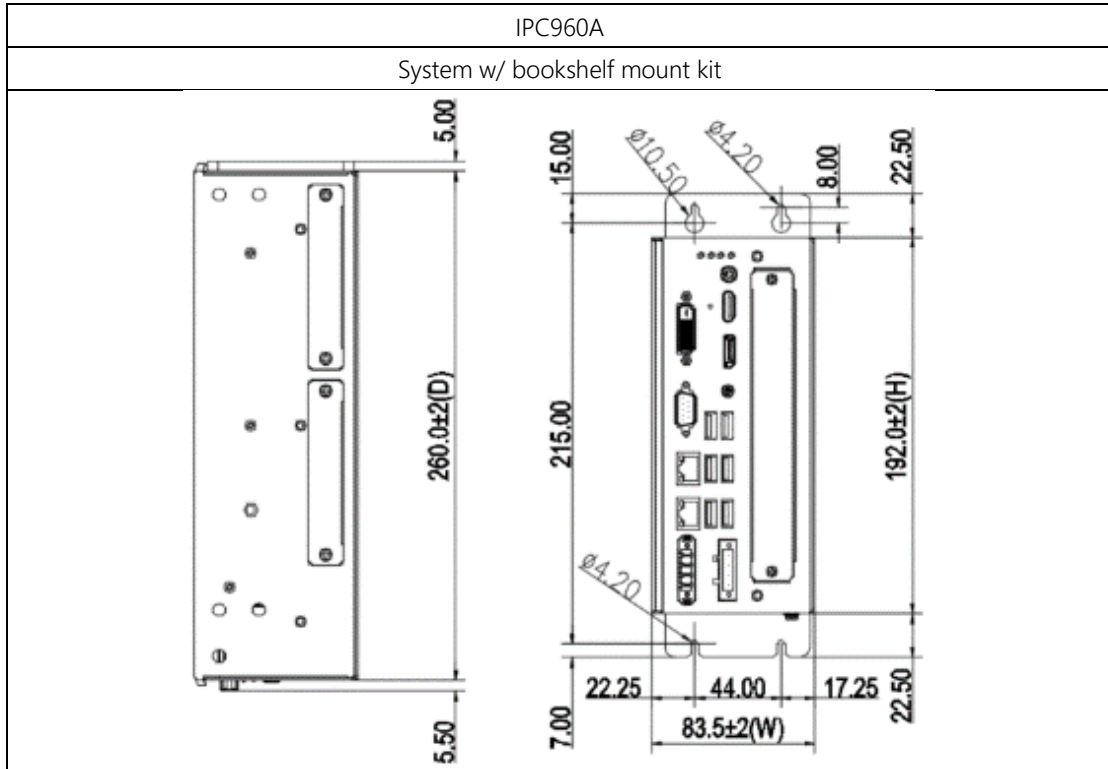

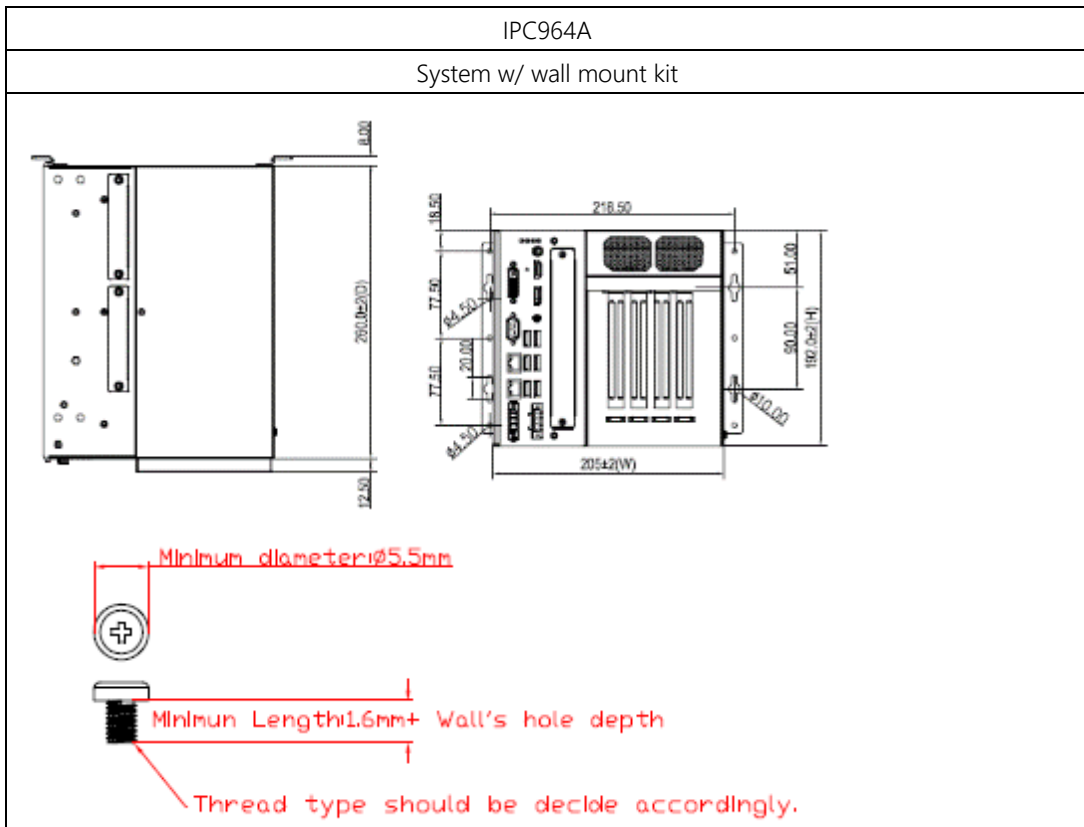
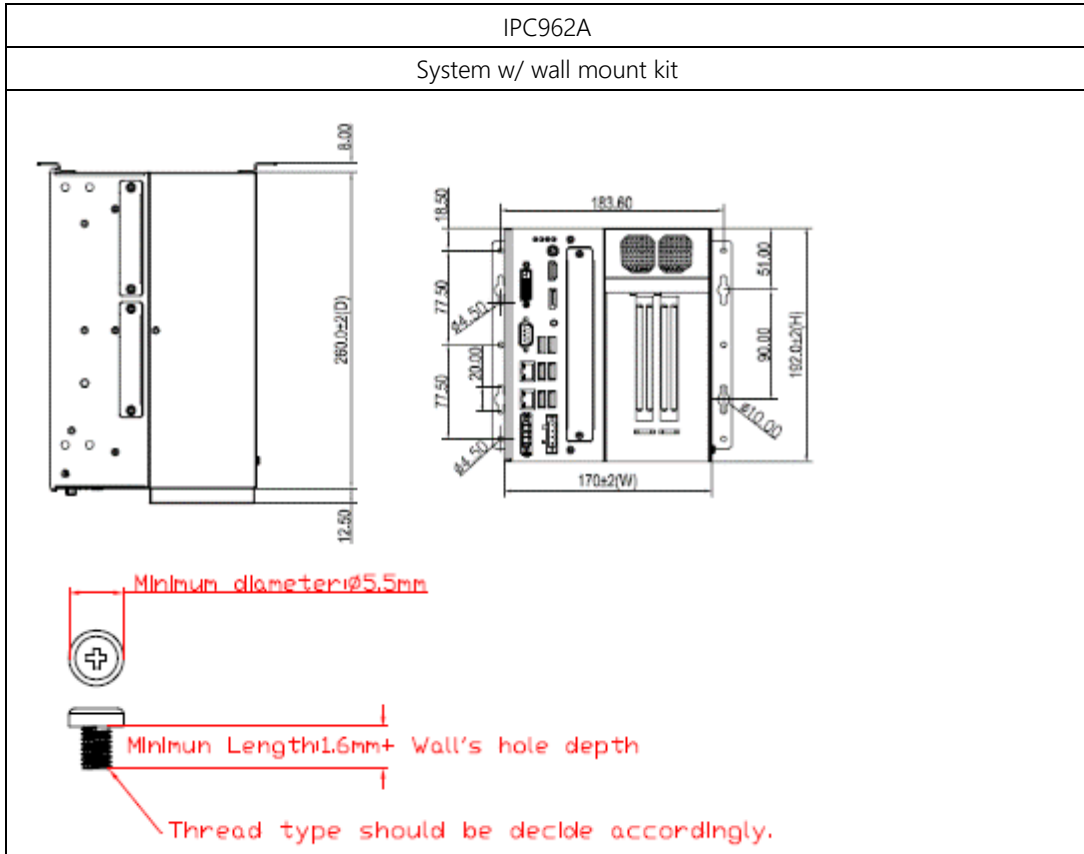

This page is intentionally left blank.

SECTION 3 AMI BIOS UTILITY

The AMI UEFI BIOS provides users with a built-in setup program to modify basic system configuration. All configured parameters are stored in a 16MB flash chip to save the setup information whenever the power is turned off. This chapter provides users with detailed description about how to set up basic system configuration through the AMI BIOS setup utility.

3.1 Starting

To enter the setup screens, follow the steps below:

1. Turn on the computer and press the key immediately.
2. After you press the key, the main BIOS setup menu displays. You can access the other setup screens from the main BIOS setup menu, such as the Advanced and Chipset menus.



Note: If your computer cannot boot after making and saving system changes with Setup, you can restore BIOS optimal defaults by setting JP1 (see section 1.6.2).

It is strongly recommended that you should avoid changing the chipset's defaults. Both AMI and your system manufacturer have carefully set up these defaults that provide the best performance and reliability.

3.2 Navigation Keys

The BIOS setup/utility uses a key-based navigation system called hot keys. Most of the BIOS setup utility hot keys can be used at any time during the setup navigation process. These keys include <F1>, <F2>, <Enter>, <ESC>, <Arrow> keys, and so on.



Note: Some of the navigation keys differ from one screen to another.

| Hot Keys | Description |
|---------------|--|
| →← Left/Right | The Left and Right <Arrow> keys allow you to select a setup screen. |
| ↑↓ Up/Down | The Up and Down <Arrow> keys allow you to select a setup screen or sub-screen. |
| +– Plus/Minus | The Plus and Minus <Arrow> keys allow you to change the field value of a particular setup item. |
| Tab | The <Tab> key allows you to select setup fields. |
| F1 | The <F1> key allows you to display the General Help screen. |
| F2 | The <F2> key allows you to Load Previous Values. |
| F3 | The <F3> key allows you to Load Optimized Defaults. |
| F4 | The <F4> key allows you to save any changes you have made and exit Setup. Press the <F4> key to save your changes. |
| Esc | The <Esc> key allows you to discard any changes you have made and exit the Setup. Press the <Esc> key to exit the setup without saving your changes. |
| Enter | The <Enter> key allows you to display or change the setup option listed for a particular setup item. The <Enter> key can also allow you to display the setup sub- screens. |

3.3 Main Menu

When you first enter the setup utility, you will enter the Main setup screen. You can always return to the Main setup screen by selecting the Main tab. System Time/Date can be set up as described below. The Main BIOS setup screen is shown below.



- BIOS Information
Display the BIOS information.
- System Date/Time
Use this option to change the system time and date. Highlight System Time or System Date using the <Arrow> keys. Enter new values through the keyboard. Press the <Tab> key or the <Arrow> keys to move between fields. The date must be entered in MM/DD/YY format. The time is entered in HH:MM:SS format.
- Access Level
Display the access level of current user.

3.4 Advanced

- Advanced Menu

The Advanced menu also allows users to set configuration of the CPU and other system devices. You can select any of the items in the left frame of the screen to go to the sub menus:

- Smart Ignition Management
- ACPI Settings
- Trusted Computing
- Platform Misc Configuration
- CPU Configuration
- Storage Configuration
- NVMe Configuration
- AMT Configuration
- F81804 Super IO configuration
- Hardware Monitor
- USB Configuration
- PCI Subsystem Settings

For items marked with "▶", please press <Enter> for more options.

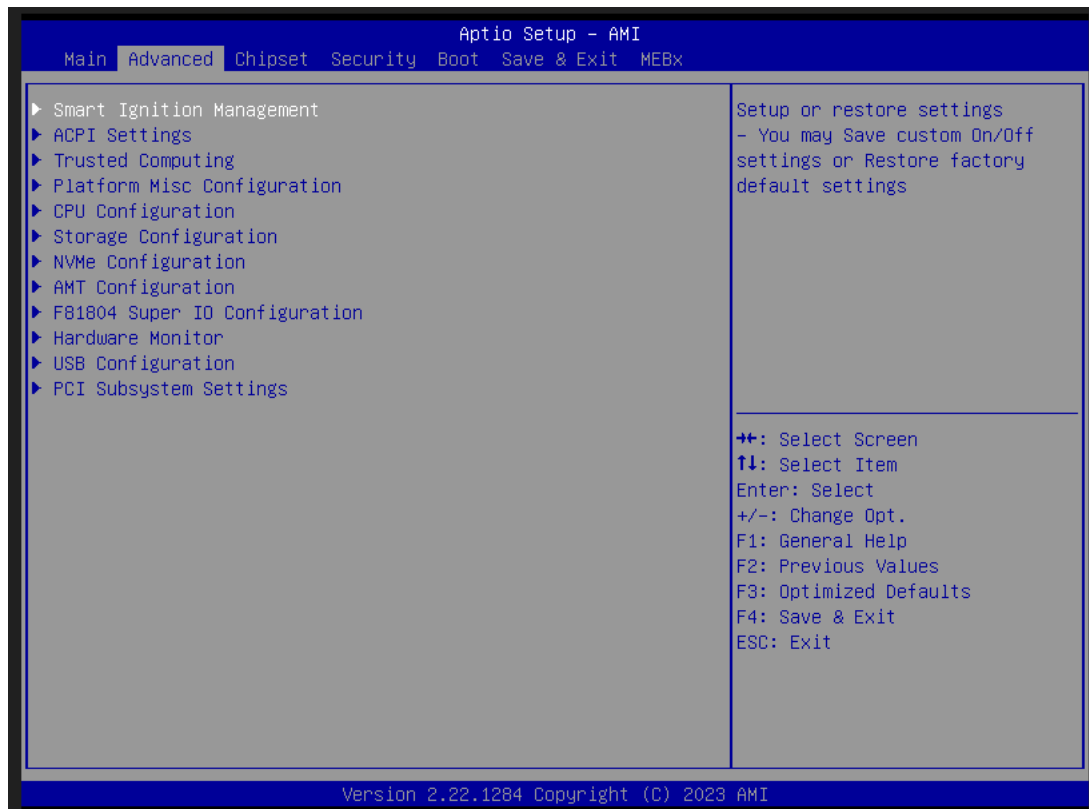

- Smart Ignition Configuration

Press Enter to access the sub-menu. Calculated based on the 24-hour military-time clock.



| BIOS menu item | Description |
|---------------------|--|
| Ignition Management | <p>Enabled</p> <p>Switch to ACC mode</p> <p>*Note: IGN signal will only be triggered when DCIN Terminal Block 4-Pin IGN is connected with VCC.</p> <p>Disabled</p> <p>Switch to AT mode</p> <p>*Note: System will be reset after Ignition Management setting has been changed and saved.</p> |
| Auto Power On | <p>Enabled</p> <p>System will turn on automatically under following conditions.</p> <ul style="list-style-type: none"> - Manually disconnects and reconnects system power - Power interruption: Resumes power after power failure <p>Disabled</p> |

| | |
|---------------------------------|---|
| | System will not turn on automatically when power is connected or when power resumes from a power failure |
| Advance Setting | Set system on/off timing and voltage threshold levels |
| Save Settings | Save the current settings |
| Restore Factory Settings | Restores factory defaults to remove any incorrect or corrupt settings that might have prevented the system from properly powering on/off. |

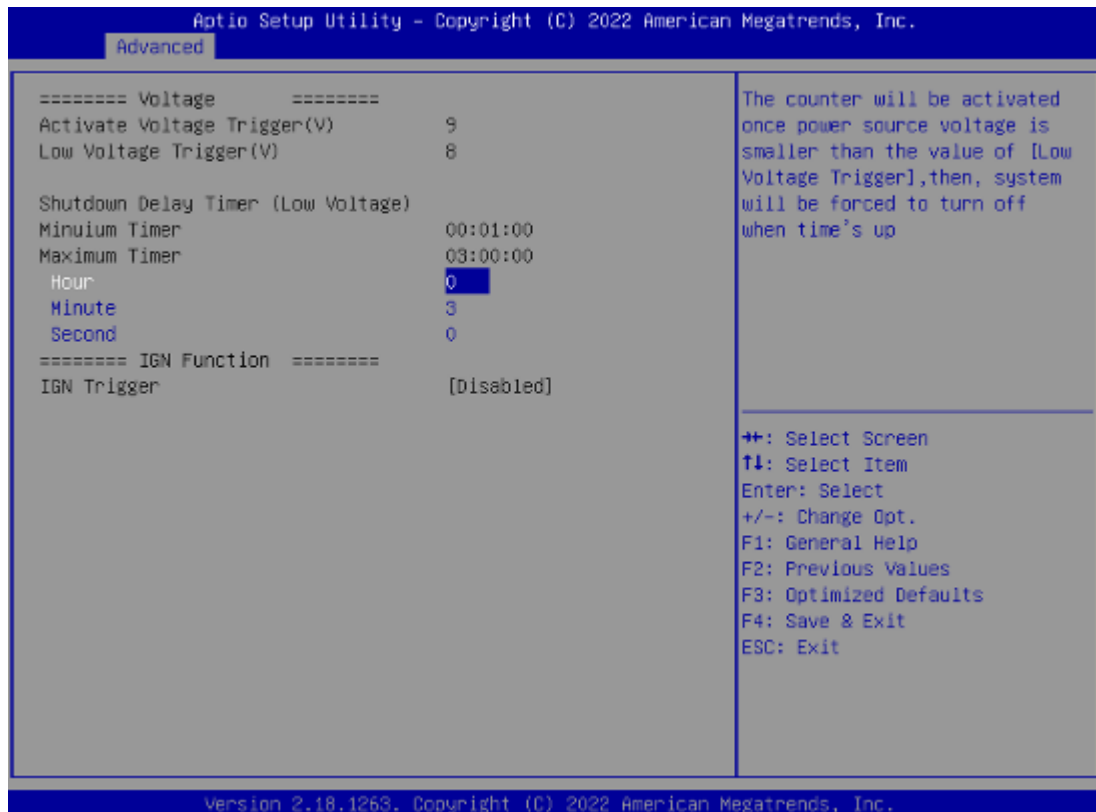

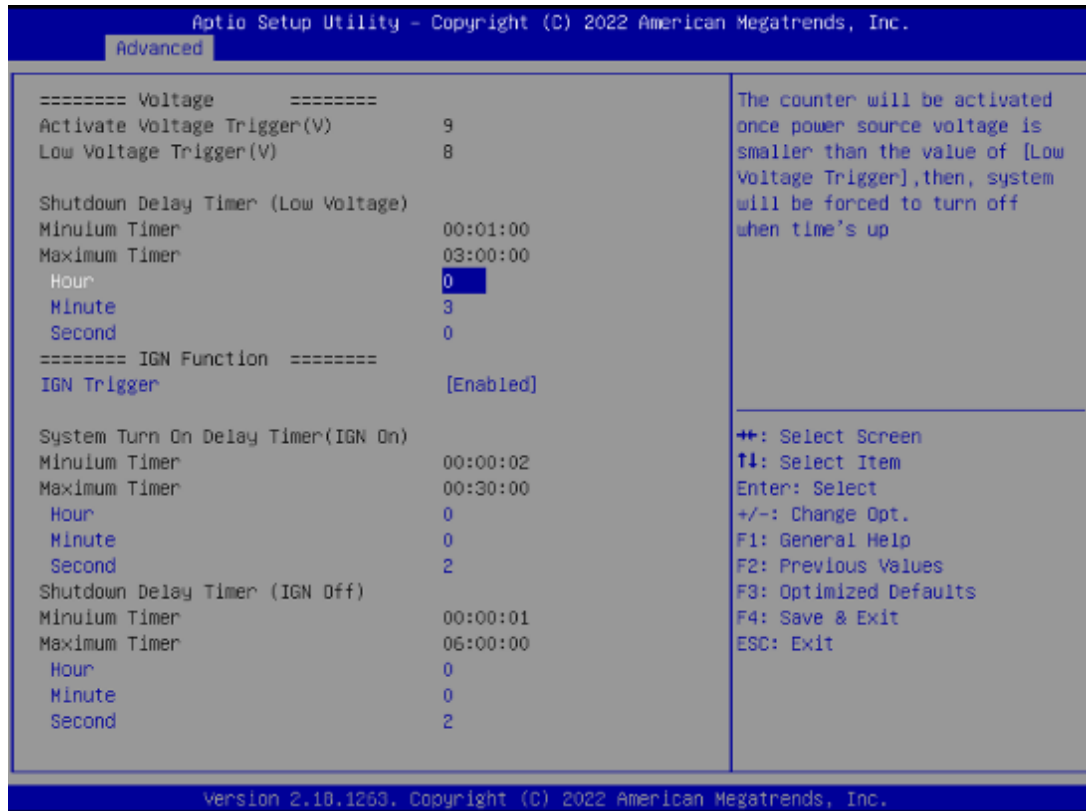

| BIOS menu item | Description |
|------------------------------------|---|
| Activate Voltage Trigger | The system only turns on when the voltage delivered by the power source is higher than the value you set here. |
| Low Voltage Trigger | The system will begin countdown stage once voltage drops below the value you set here. If the power source voltage does not come back above the value of [Activate Voltage Trigger] within the time you set for [Shutdown Delay Time (Low Voltage)], the system will shut down and remain off. |
| Shutdown Delay Timer (Low Voltage) | The counter will be activated once power source voltage drops below the value defined in [Low Voltage Trigger]. The system will be forced to turn off once timer completes countdown. |
| IGN Trigger | Enable [System Turn on Delay] and [Shutdown Delay] will be triggered by IGN. Disable IGN signal will not affect any power management. |

- ACPI Settings

ACPI configuration can be configured in ACPI Settings. A description of the selected item appears on the right side of the screen.

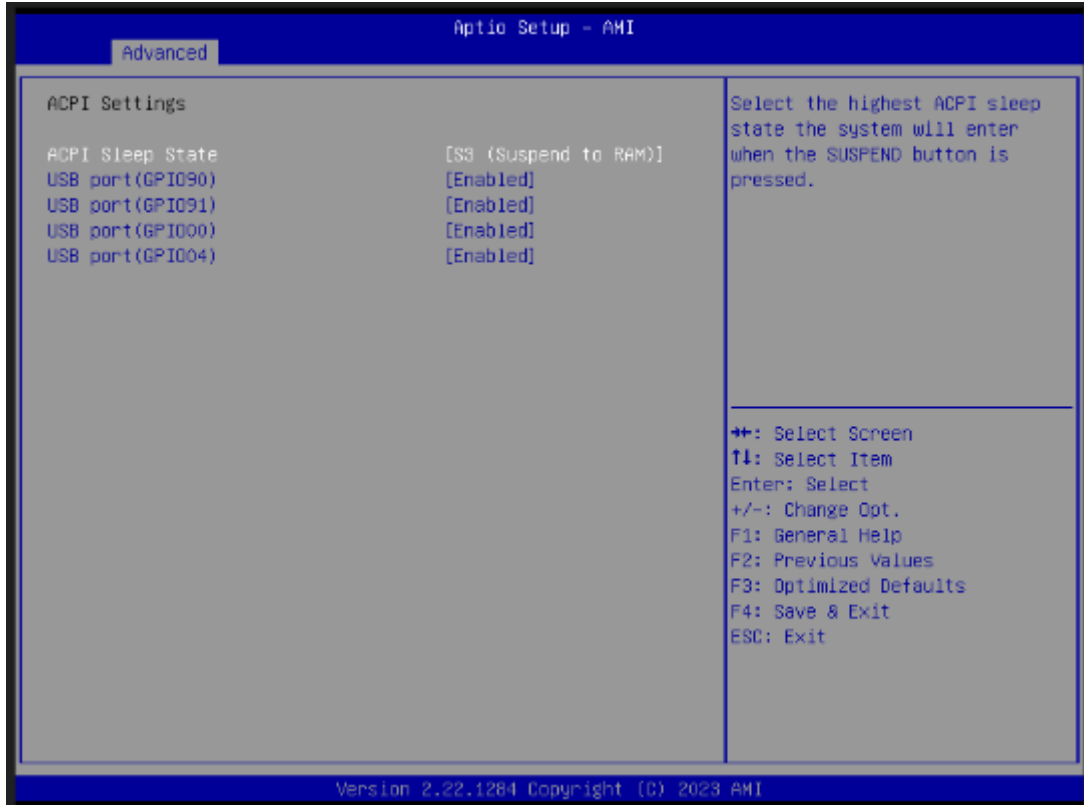

- ACPI Sleep State

Select the ACPI (Advanced Configuration and Power Interface) sleep state. Configuration options are Suspend Disabled and S3 (Suspend to RAM). The default is S3 (Suspend to RAM). This option selects the ACPI sleep state the system will enter when the suspend button is pressed.

- USB Port

Set whether the USB Port needs to provide USB power in ACPI power saving mode. The default is on. For additional control methods, please contact Axiomtek

- Trusted Computing

Select Security Device Support to enable or disable the TPM function.



- TPM Device Selection

Select TPM device:

- PTT: Intel® built-in TPM. Enables PTT in SkuMgr.
- dTPM: External extended Infineon's TPM. Disables PTT in SkuMgr.

- Security Device Support

Enable or disable BIOS support for security device. OS will not show security device. TCG EFI protocol and INT1A interface will not be available.

- Platform Misc Configuration

This screen allows you to set Platform Misc Configuration.

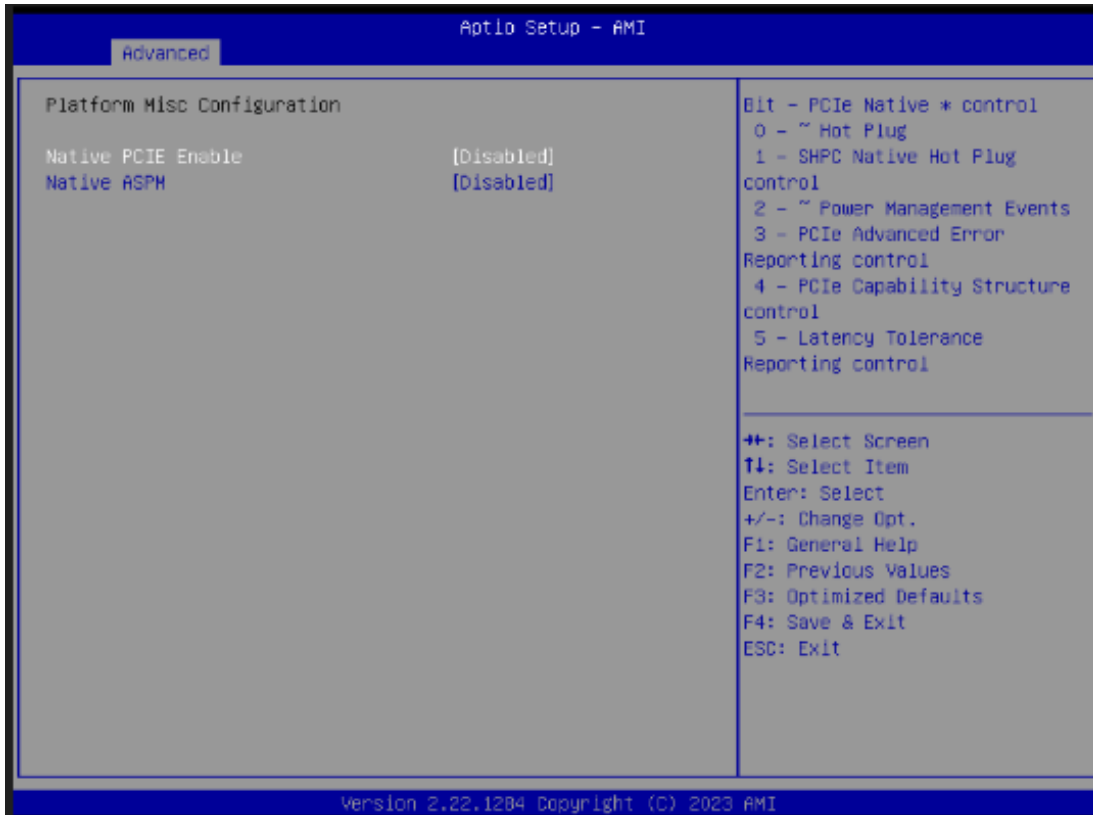

- Native PCIE Enable
Enabled - Enable PCIE power saving function, Disabled - Disabled PCIE power saving function.
- Native ASPM
Enabled - OS Controlled ASPM, Disabled - BIOS Controlled ASPM.

- CPU Configuration

This screen shows the CPU configuration, and you can change the value of the selected option.

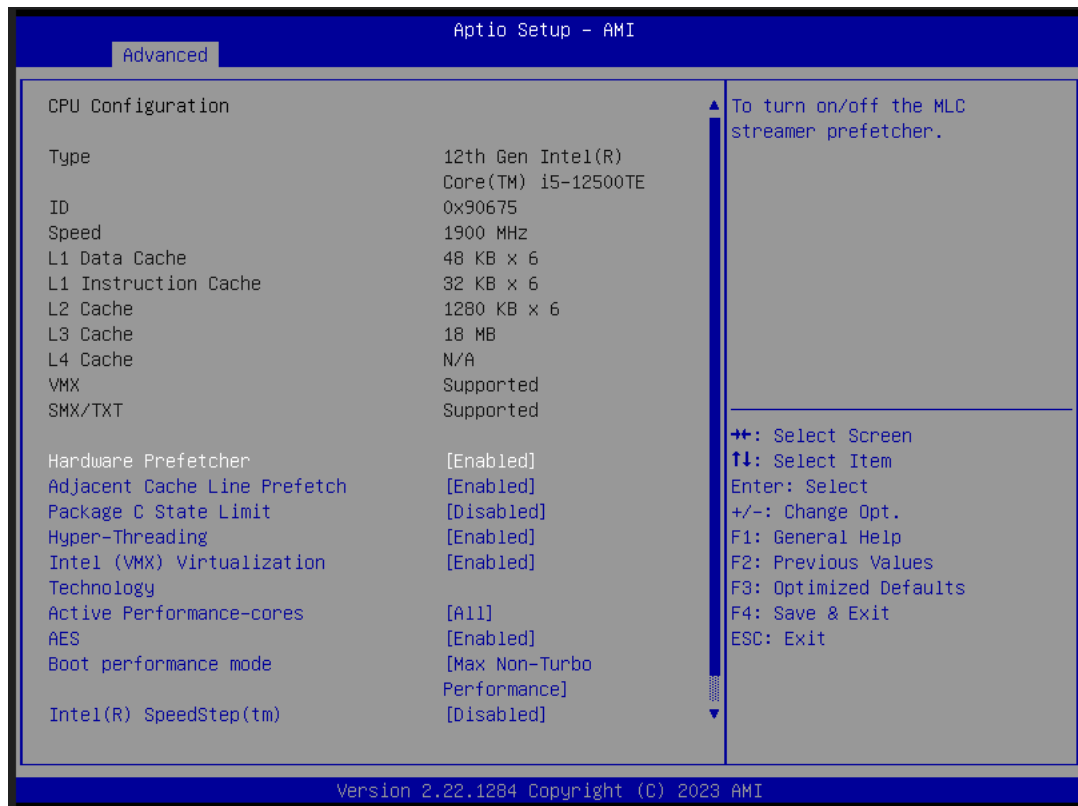

- **Hardware Prefetcher**
Turn on/off the MLC streamer prefetcher.
- **Adjacent Cache Line Prefetch**
Turn on/off prefetching of adjacent cache lines.
- **Package C State Limit**
Maximum Package C State Limit Setting. CPU Default: Sets to Factory default value. Auto: Initializes to deepest available Package C State Limit.
- **Hyper-Threading**
Enable or disable Hyper-threading Technology, which allows a single physical processor to multitask as multiple logical processors. When disabled, only one thread per enabled core is enabled.
- **Intel Virtualization Technology**
Enable or disable Intel Virtualization Technology. When enabled, a VMM (Virtual Machine Mode) can utilize the additional hardware capabilities. It allows a platform to run multiple operating systems and applications independently, hence enabling a single computer system to work as several virtual systems.
- **Active Performance Cores**
Number of cores to enable in each processor package.

- Active Efficient Cores
Number of E-cores to enable in each processor package. Note: Number of P-Cores and E-cores are counted together. When both are {0,0}, P-code will enable all cores.
AES
Enable / Disable AES (Advanced Encryption Standard)
- Boot performance mode
Select the performance mode that the BIOS will run after the reset.
- Intel (R) SpeedStep(tm)
Allows more than two frequency ranges to be supported.
- Turbo Mode
Allows to enable processor cores to raise the operating frequency.

- Storage Configuration

This screen shows storage information.

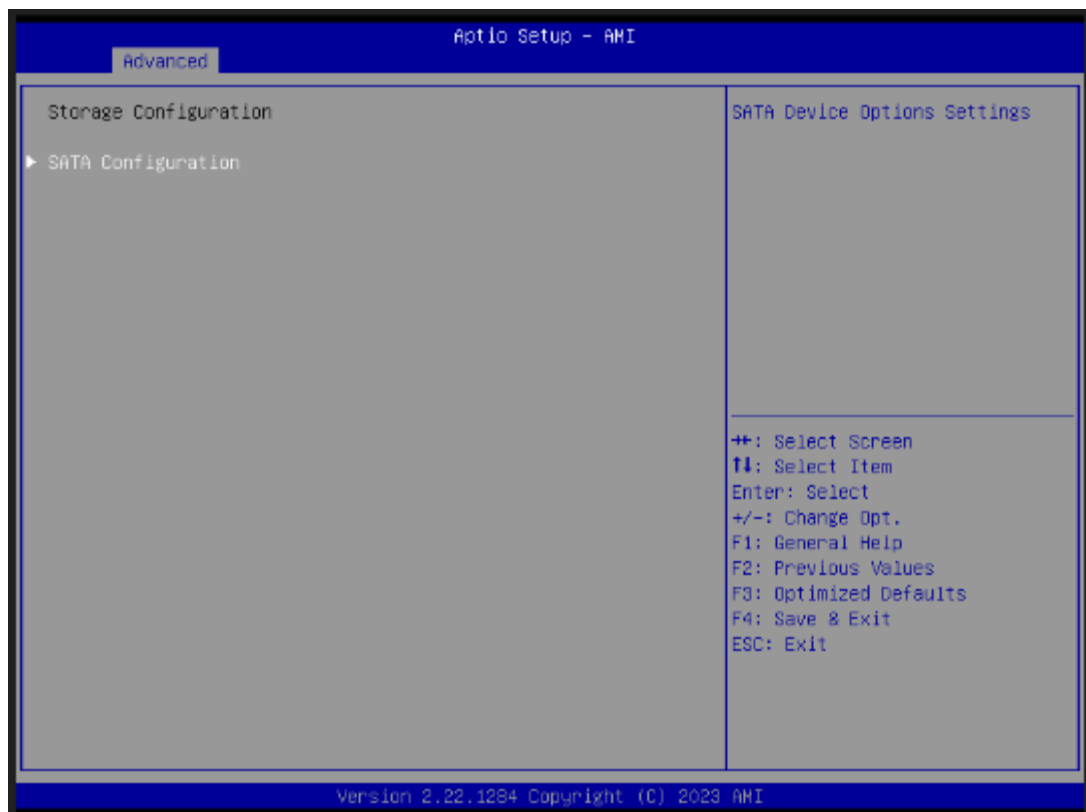

- SATA Configuration

During system boot up, the BIOS automatically detects the presence of SATA devices. In the SATA Configuration menu, you can see the hardware currently installed in the SATA ports.

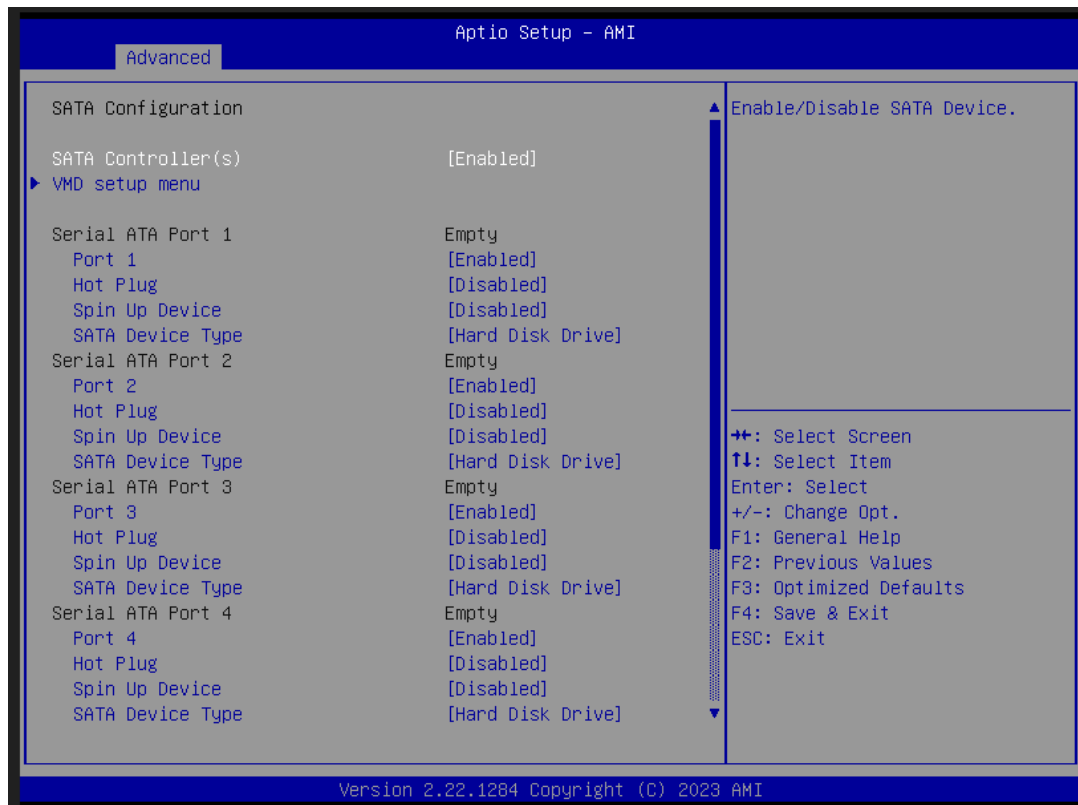

- SATA Controller(s)
Enable or disable the SATA Controller feature. The default is Enabled.
- VMD Setup Menu
VMD Configuration settings. The default is Disabled.
- Hot Plug
Designates this port as Hot Pluggable.
- Spin Up Device
Staggered Spin Up will be performed when any of the drive is enabled for the performance strategy. Otherwise, all drives spin up at boot. Only HDD supports this function.
- SATA Device Type
Identify the SATA port is connected to a solid-state drive (SSD) or hard disk drive (HDD).

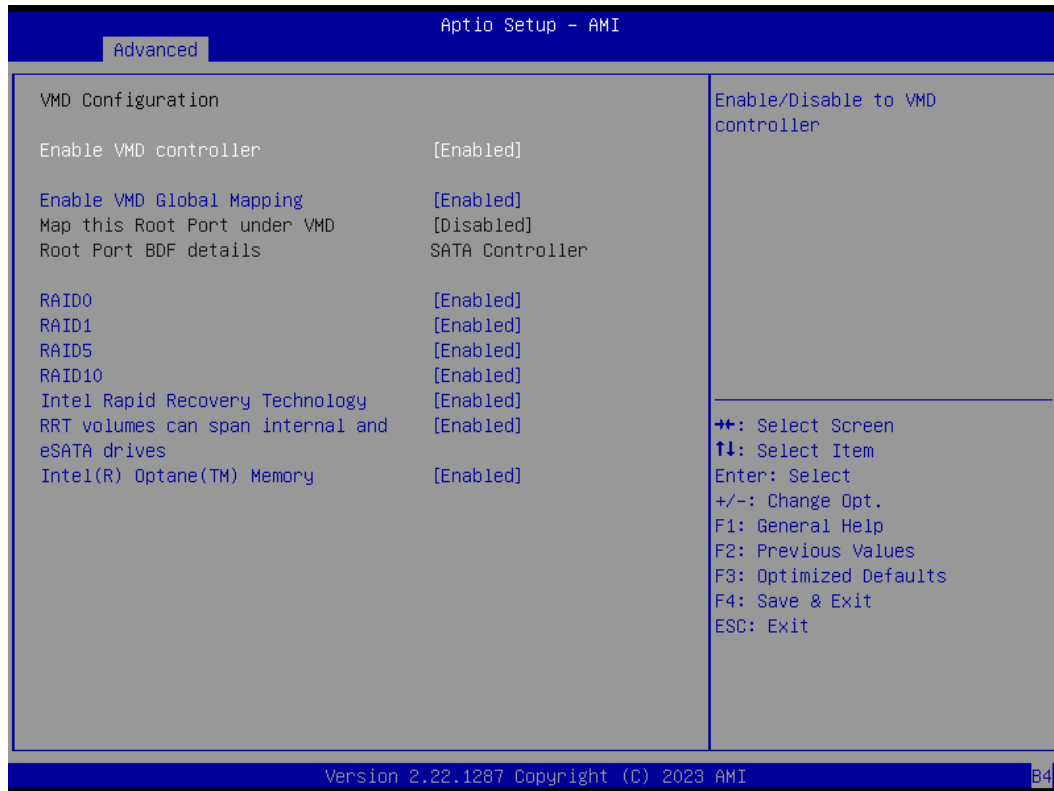

- NVMe Configuration

This screen shows NVMe device information.

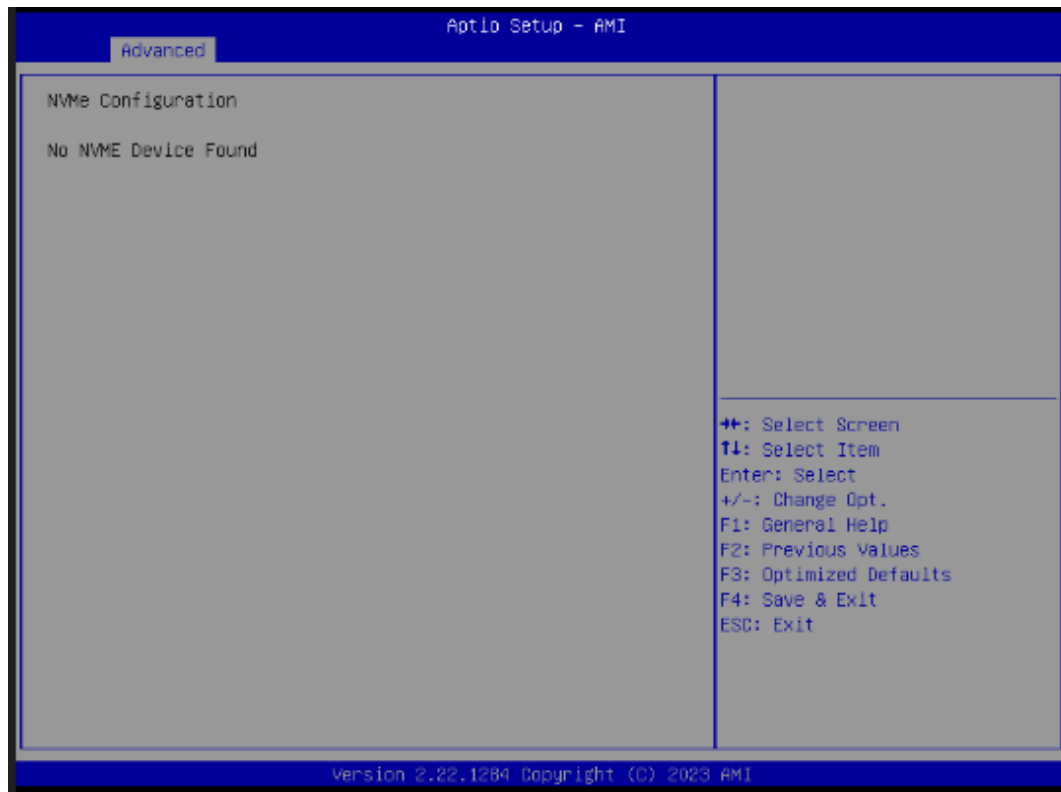

- AMT Configuration

This screen displays Active Management Technology information.



- AMT BIOS Features
Enable or disable Active Management Technology BIOS features. The default is Enabled.

- F81804 Super IO Configuration

You can use this screen to select options for the Super IO Configuration and change the value of the selected option. A description of the selected item appears on the right side of the screen. For items marked with "▶", please press <Enter> for more options.



➤ Serial Port 1

This item allows you to use it as RS232/422/485. The default is RS232.

- Serial Port 1 Configuration

Use these items to set parameters related to serial port 1.

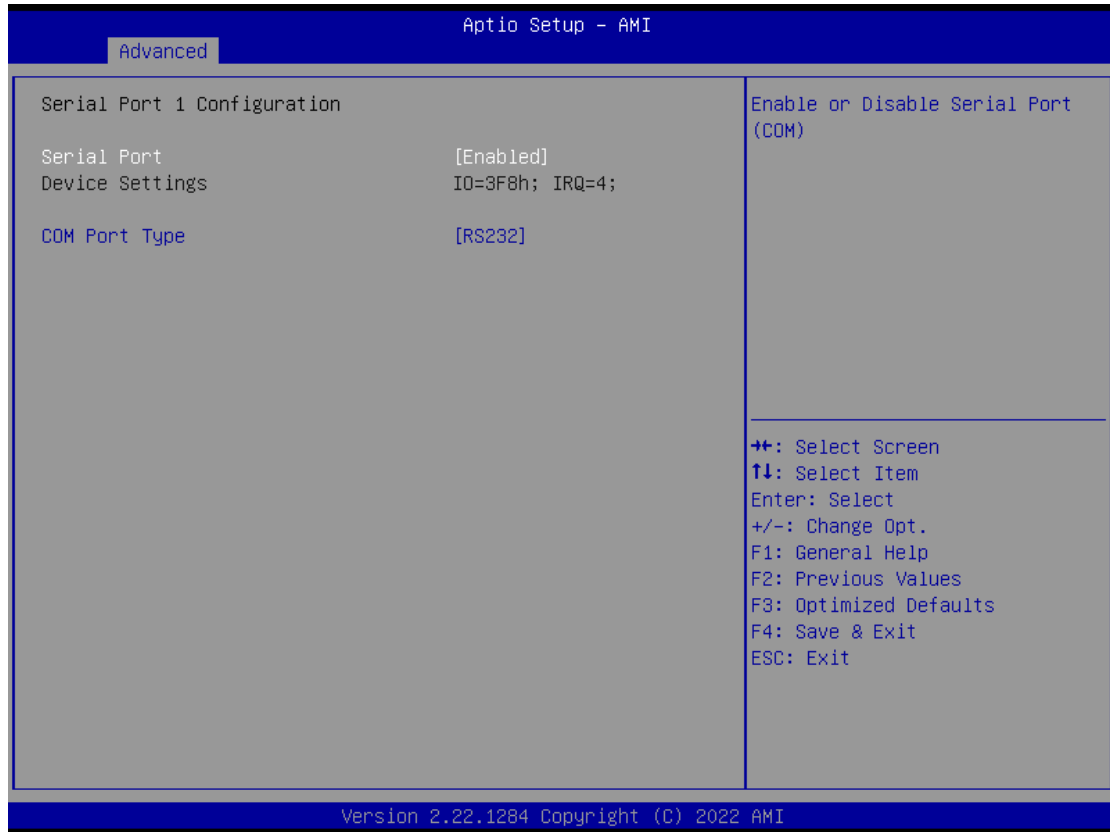

➤ Serial Port 1

This item allows you to use it as RS232/422/485. The default is RS232.

- Hardware Monitor

This screen monitors hardware health status.



This screen displays the temperature of system and CPU, cooling fans speed in RPM and system voltages (VCC_CPU, DDR, +12V, +5V and +3.3V).



Note: Fan module is an option kit, fans speed will be displayed when it is installed in IPC962A and IPC964A.

- USB Configuration

This screen shows USB configuration.

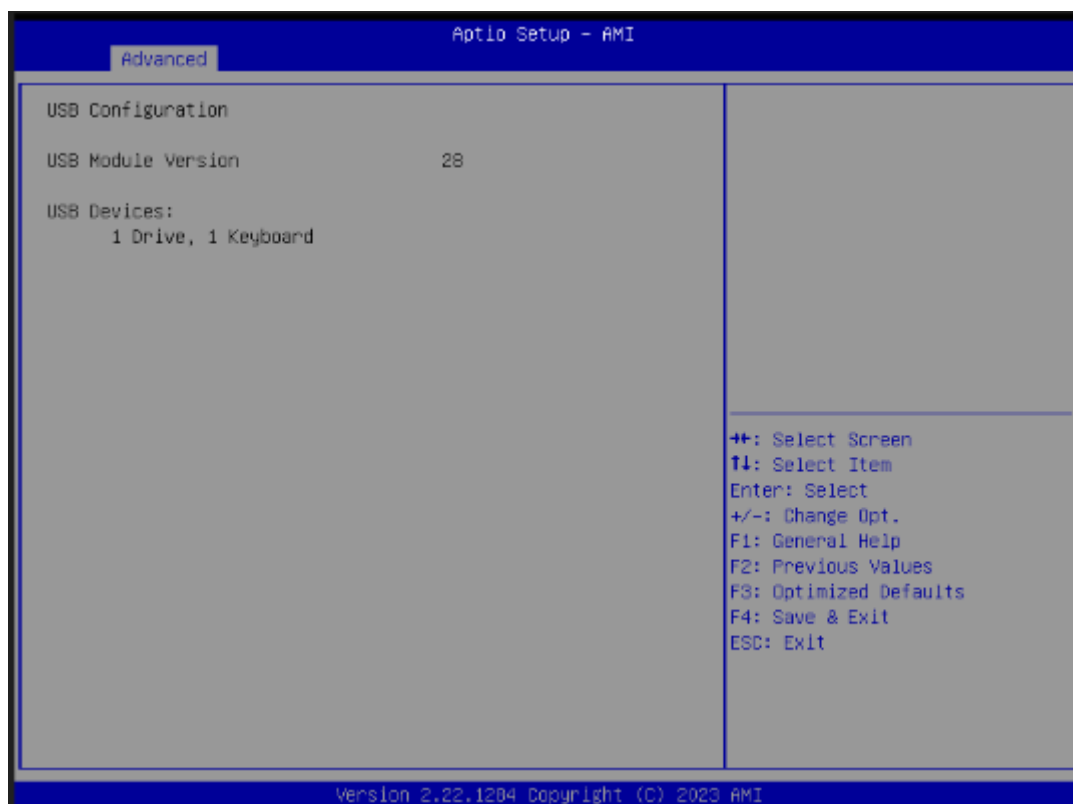

- PCI Subsystem Setting

This screen allows you to set PCI Subsystem mode.



- PCI Latency Timer
Set the value to be programmed into PCI Latency Timer Register.
- VGA Palette Snoop
Enables or Disables VGA Palette Registers Snooping.

3.5 Chipset Menu

The Chipset menu allows users to change the advanced chipset settings. You can select any of the items in the left frame of the screen to go to the sub menus:

- System Agent (SA) Configuration
- PCH-IO Configuration

For items marked with "▶", please press <Enter> for more options.

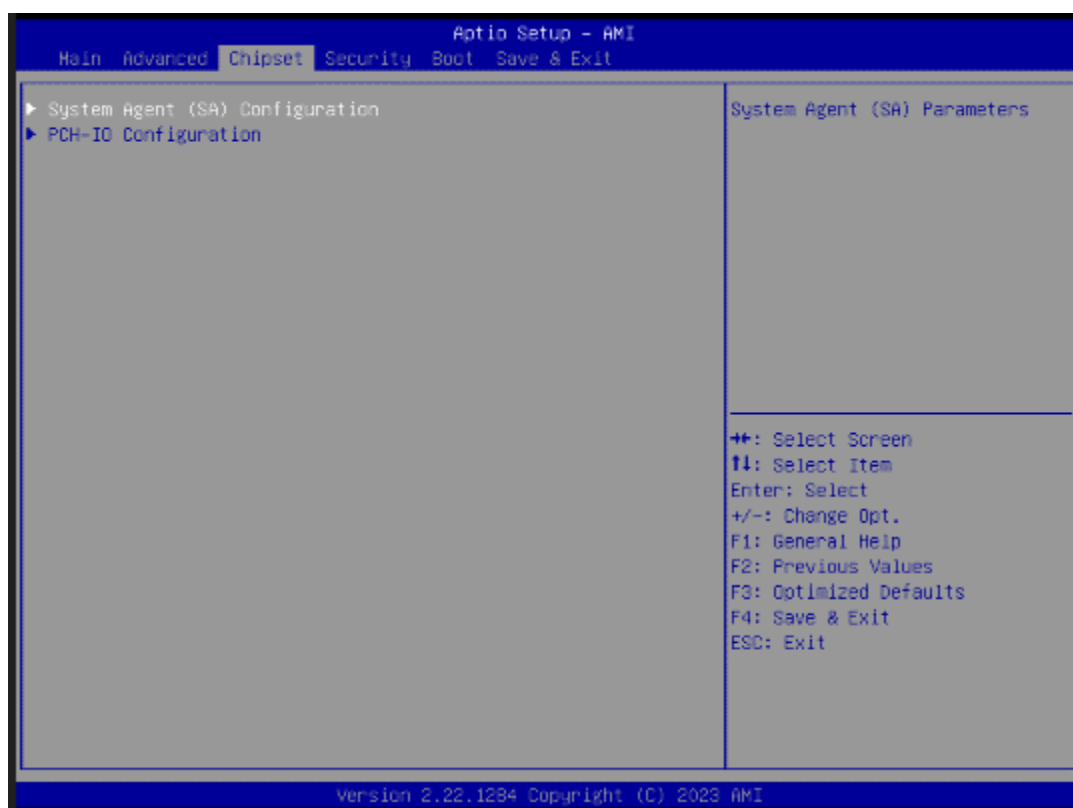

- System Agent (SA) Configuration

This screen allows users to configure System Agent (SA) parameters. For items marked with "▶", please press <Enter> for more options.



- VT-d
 - Check to enable VT-d function on MCH.
- Above 4GB MMIO BIOS assignment
 - Enable/Disable above 4GB Memory Mapped IO BIOS assignment. This is enabled automatically when Aperture Size is set to 2048MB.

- Graphics Configuration

This screen shows graphics configuration.



- Internal Graphics
 - Keep IGFX enabled based on the setup options.

- CPU PCI Express Root Port

This screen shows CPU PCI Express root port information.

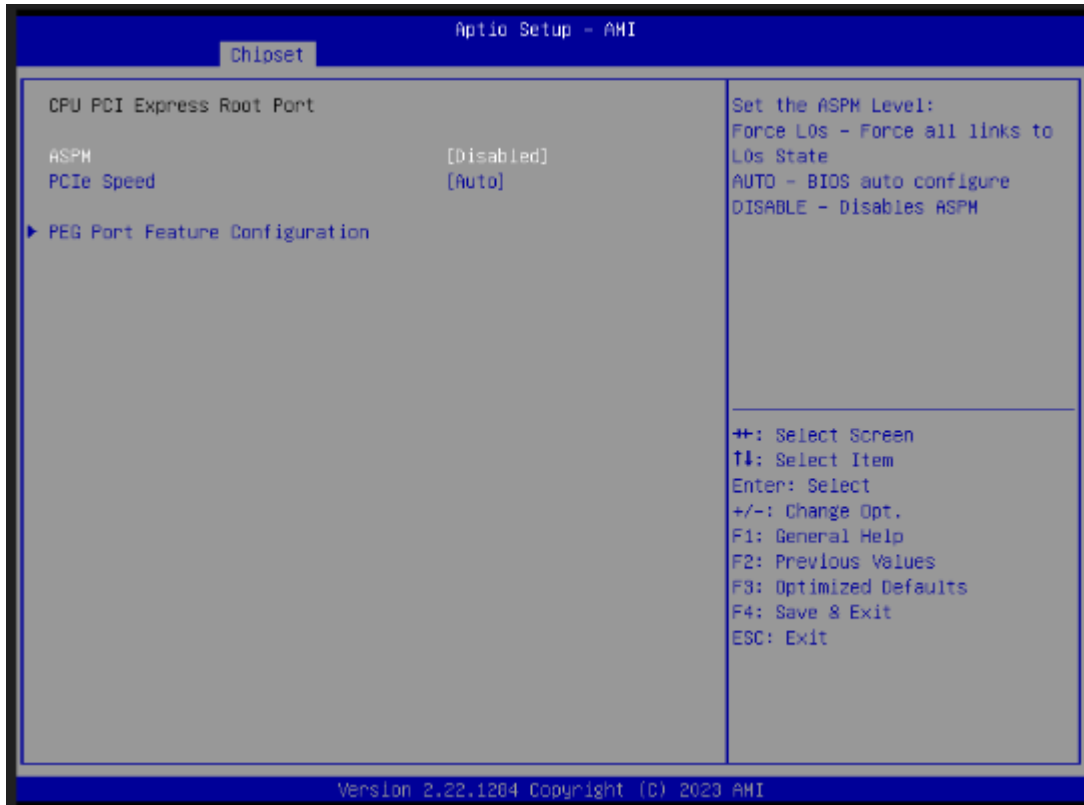

- ASPM

Set the ASPM Level:
Force L0s - Force all links to L0s State
Force L1 - Force all links to L1 State
Force L0sL1 - Force all links to LOSL1 State
DISABLE - Disables ASPM.

- PCIe Speed

Configure PCIe Speed.

- PEG Port Feature Configuration

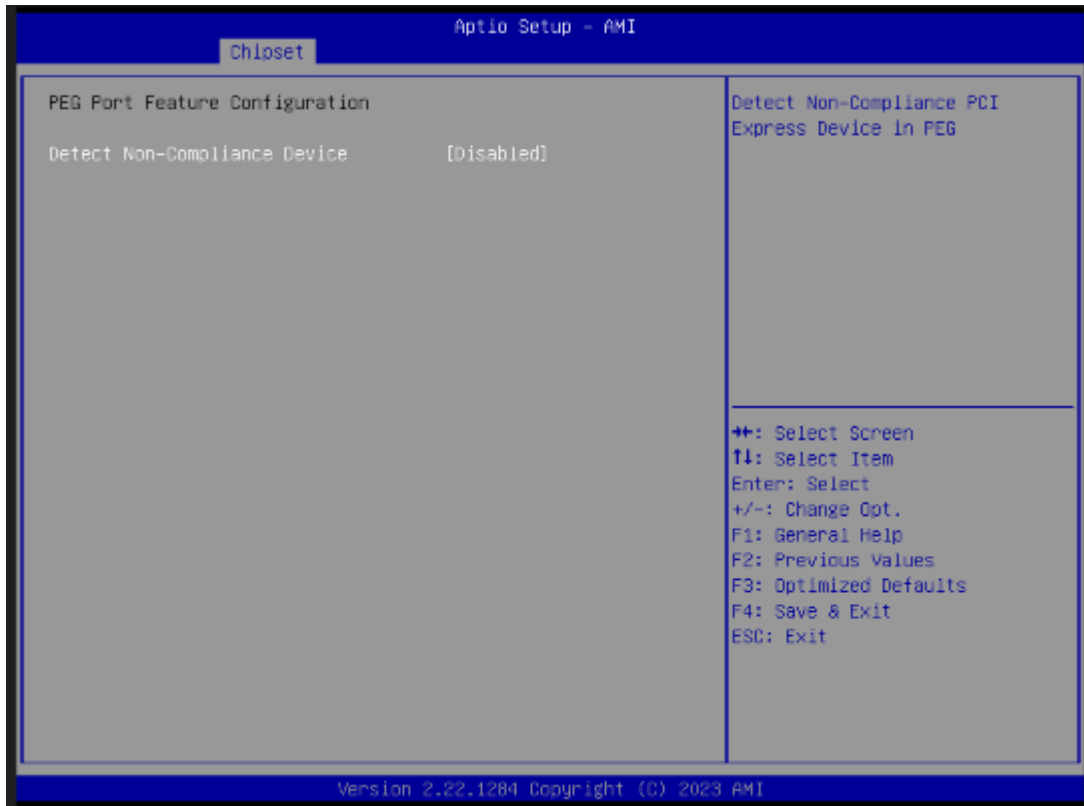

- PCH-IO Configuration

This screen allows you to set PCH parameters.



- PCI Express Configuration
Configure PCIe Speed.
- HD Audio Configuration
Enable or disable HD Audio.
- Wake on LAN Enable
Enable or disable integrated LAN to wake the system.

- HD Audio Configuration

This screen shows HD Audio information

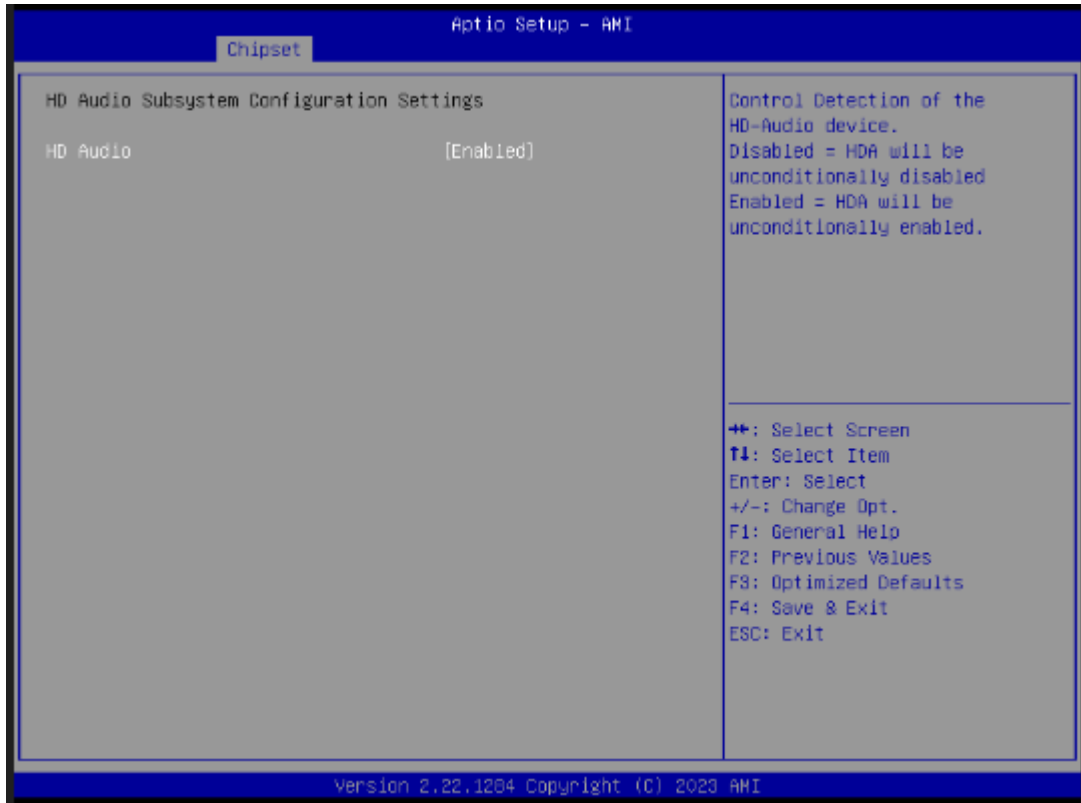

- PCI Express Configuration

This screen shows the extended use of PCI Express configuration.

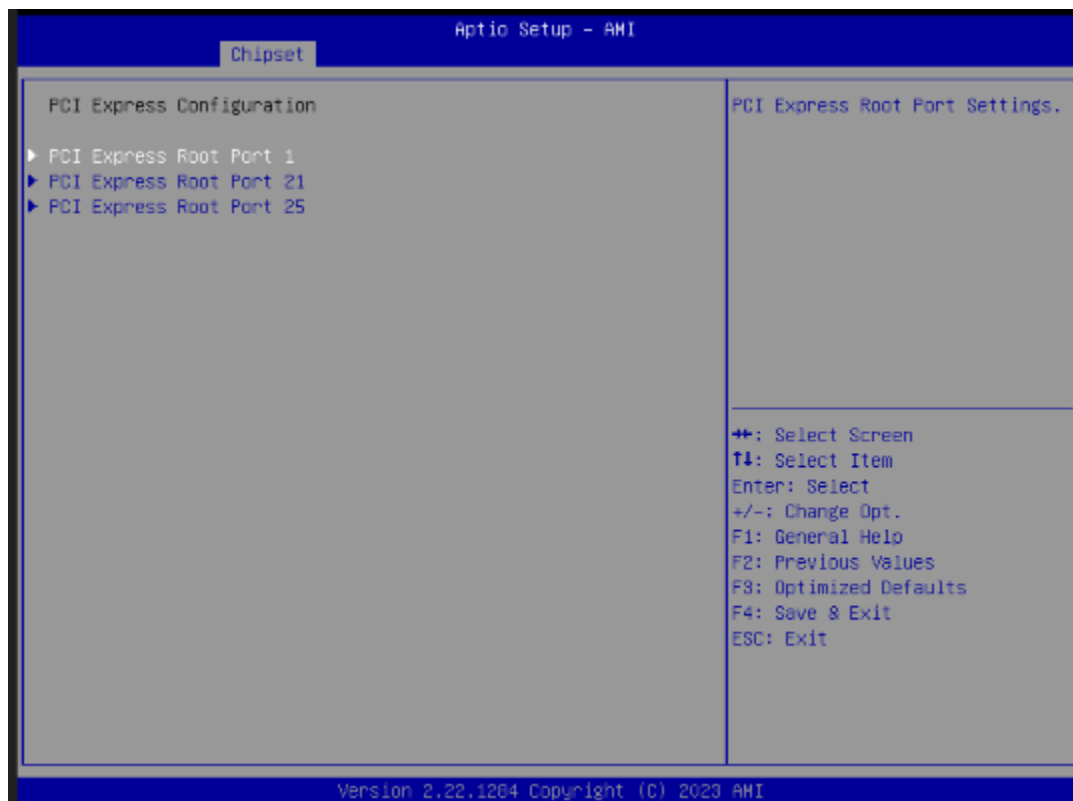

- PCI Express Root Port

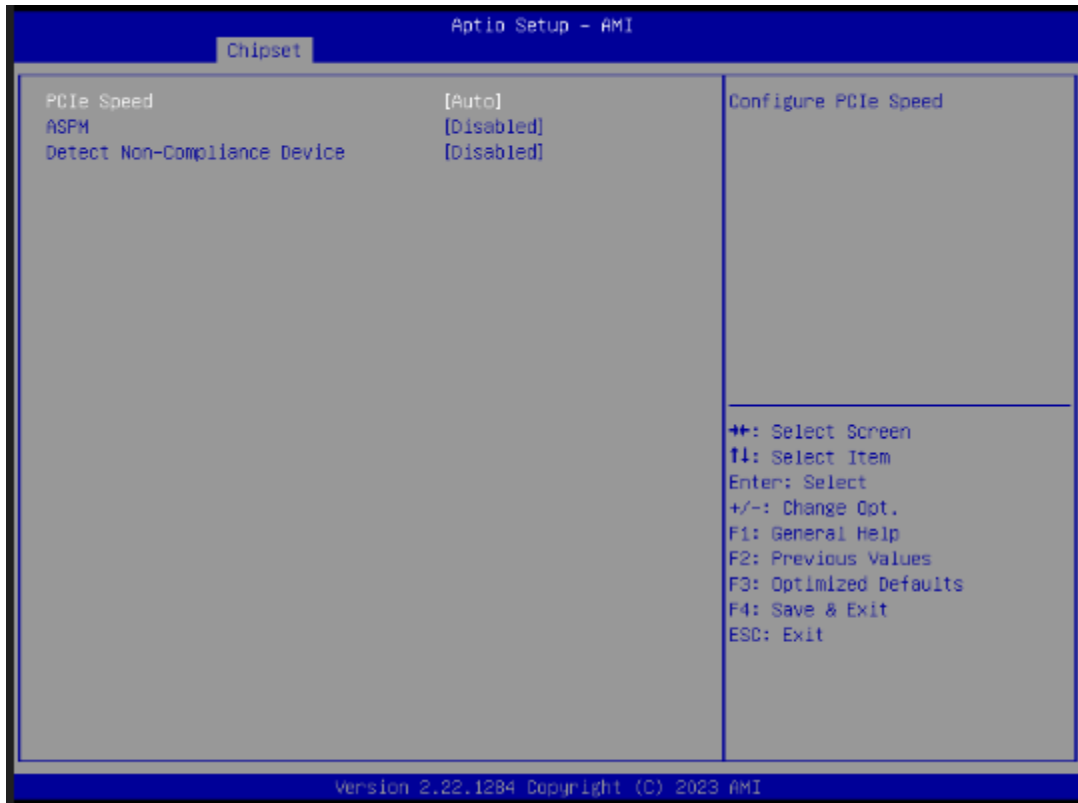

3.6 Security Menu

The Security menu allows users to change the security settings for the system.

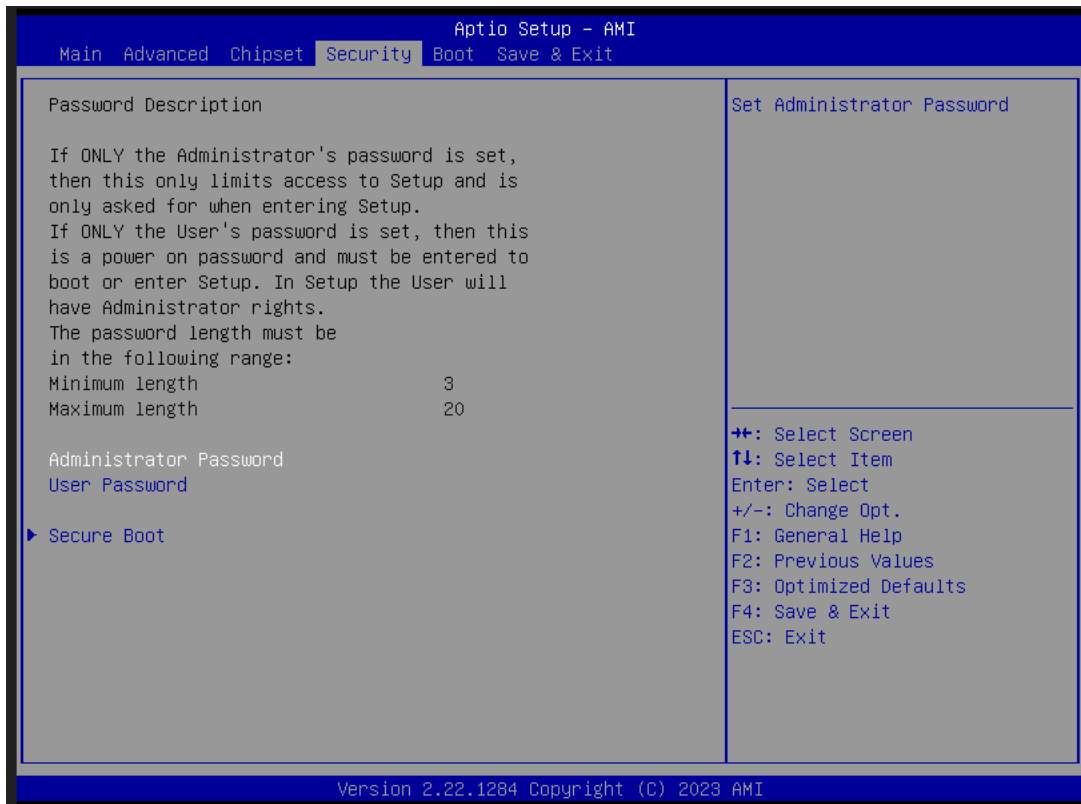

➤ Administrator Password

This item indicates whether an administrator password has been set (installed or uninstalled).

➤ User Password

This item indicates whether a user password has been set (installed or uninstalled).

- Secure Boot

This item is available on the UEFI firmware to provide a secure environment.



3.7 Boot Menu

The Boot menu allows users to change boot options of the system.

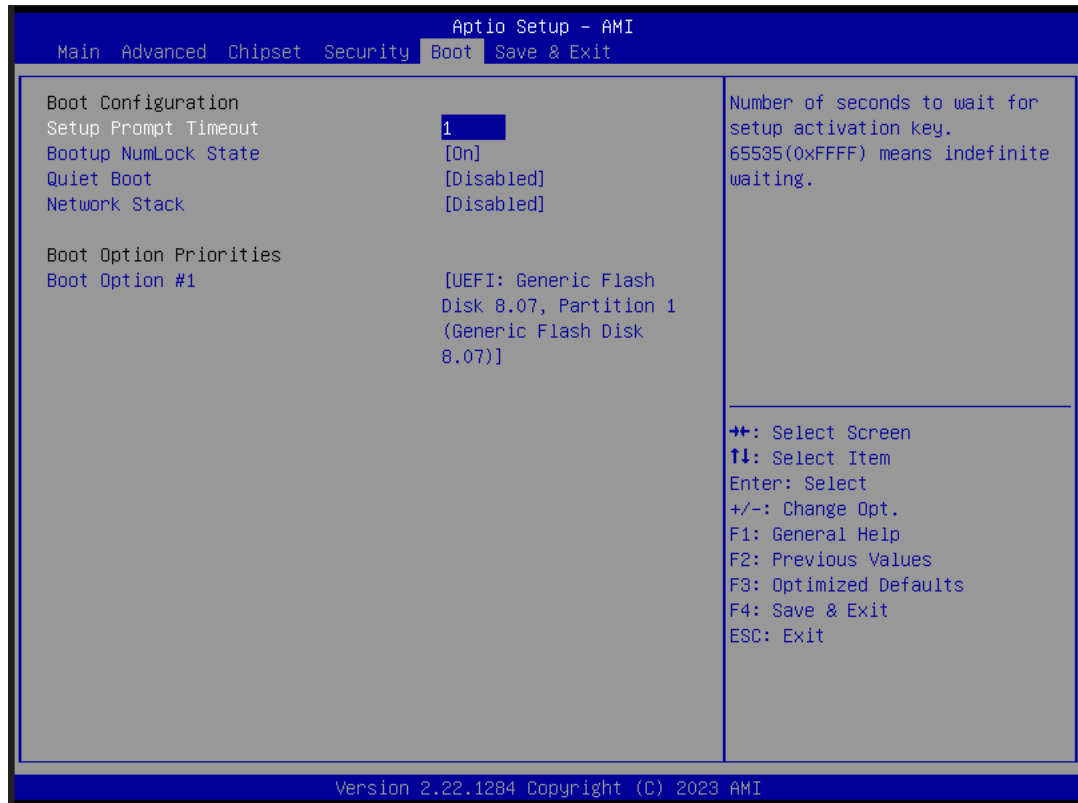

- Setup Prompt Timeout
Set the number of seconds to wait for setup activation key. 65535(0xFFFF) means indefinite waiting.
- Bootup NumLock State
Use this item to select the power-on state for the keyboard NumLock.
- Quiet Boot
Select to display either POST output messages or a splash screen during boot-up.
- Launch PXE OpROM policy
Use this item to enable or disable the boot ROM function of the onboard LAN chip when the system boots up.
- Boot Option Priorities
These are settings for boot priority. Specify the boot device priority sequence from the available devices.

3.8 Save & Exit Menu

The Save & Exit menu allows users to load your system configuration with optimal or fail-safe default values.

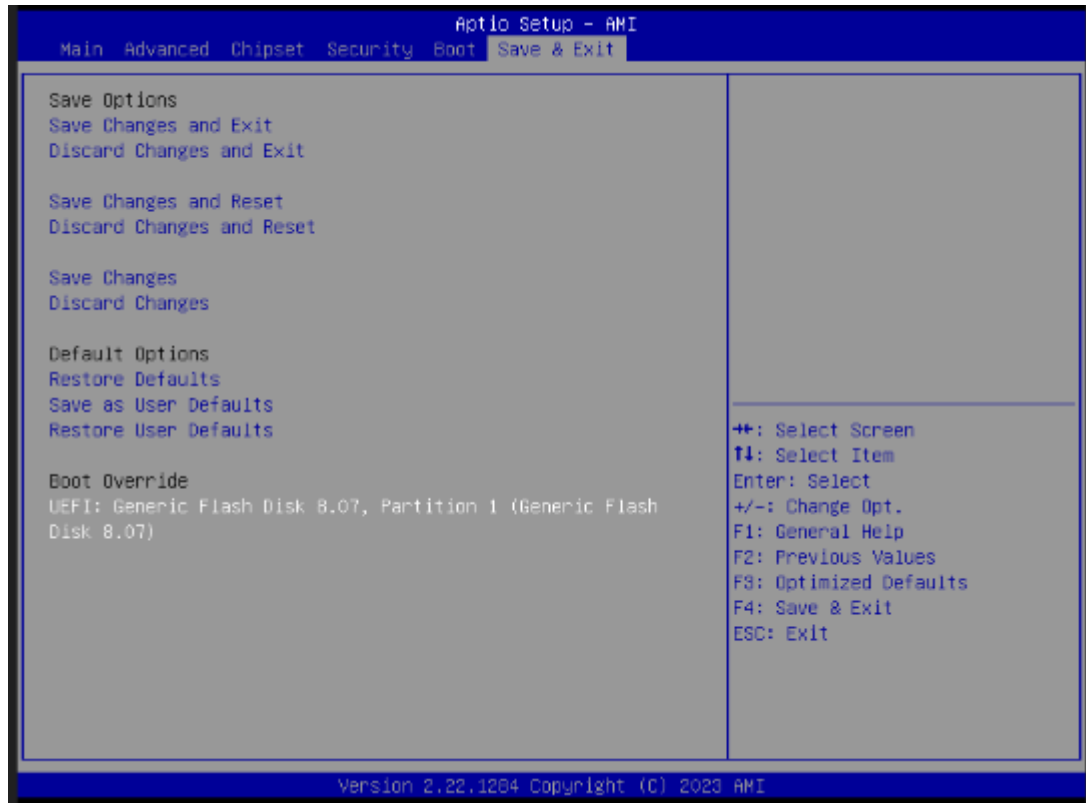

- **Save Changes and Exit**
When finishing the system configuration settings, select this option to leave Setup and return to Main Menu. Select Save Changes and Exit from the Save & Exit menu and press <Enter>. Select Yes to save changes and exit.
- **Discard Changes and Exit**
Select this option to quit Setup without making any permanent changes to the system configuration and return to Main Menu. Select Discard Changes and Exit from the Save & Exit menu and press <Enter>. Select Yes to discard changes and exit.
- **Save Changes and Reset**
When finishing the system configuration settings, select this option to leave Setup and reboot the computer so the new system configuration parameters can take effect. Select Save Changes and Reset from the Save & Exit menu and press <Enter>. Select Yes to save changes and reset.
- **Discard Changes and Reset**
Select this option to quit Setup without making any permanent changes to the system configuration and reboot the computer. Select Discard Changes and Reset from the Save & Exit menu and press <Enter>. Select Yes to discard changes and reset.

- **Save Changes**
When finishing the system configuration settings, select this option to save changes. Select Save Changes from the Save & Exit menu and press <Enter>. Select Yes to save changes.
- **Discard Changes**
Select this option to quit Setup without making any permanent changes to the system configuration. Select Discard Changes from the Save & Exit menu and press <Enter>. Select Yes to discard changes.
- **Restore Defaults**
After selecting this option, all the settings will be restored to defaults automatically. Select Restore Defaults from the Save & Exit menu and press <Enter>.
- **Save as User Defaults**
Select this option to save your current system configuration settings as User Defaults. Select Save as User Defaults from the Save & Exit menu and press <Enter>.
- **Restore User Defaults**
After selecting this option, all the settings will be restored to user defaults automatically. Select Restore User Defaults from the Save & Exit menu and press <Enter>.
- **Boot Override**
Select a drive to immediately boot that device regardless of the current boot order.

APPENDIX A WATCHDOG TIMER

A.1 About Watchdog Timer

Software stability is a major issue in most applications. Some embedded systems are not watched by an operator for 24 hours. It is usually too late to wait for someone to reboot when computer hangs. The systems need to be able to reset automatically when things go wrong. The watchdog timer gives us a solution in this regard.

The watchdog timer is a counter that triggers a system reset when it counts down to zero from a preset value. The software starts the counter with an initial value and must reset it periodically. If the counter ever reaches zero which means the software has crashed, the system will reboot.

A.2 Sample Program

```
#include "stdafx.h"

#include <windows.h>
#include <stdio.h>
#include <tchar.h>
#include <stdlib.h>
#ifdef _DEBUG
#define new DEBUG_NEW
#endif
#pragma comment (lib, "User32.lib" )
#define IDT_TIMER WM_USER + 200
#define _CRT_SECURE_NO_WARNINGS 1
#define setbit(value,x) (value |= (1<<x))
#define clrbit(value,x) (value &= ~(1<<x))
HINSTANCE hinstLibDLL = NULL;

LONG WDTDATA = 0;

typedef ULONG(*LPFNDDLGETIOSPACE)(ULONG);
LPFNDDLGETIOSPACE lpFnDll_Get_IO;
typedef void(*LPFNDDLSETIOSPACE)(ULONG, ULONG);
LPFNDDLSETIOSPACE lpFnDll_Set_IO;
int _tmain(int argc, _TCHAR* argv[])
```

```
{
int unit = 0;
int WDTtimer = 0;
if (hinstLibDLL == NULL)
{
hinstLibDLL = LoadLibrary(TEXT("diodll.dll"));
if (hinstLibDLL == NULL)
{
//MessageBox("Load diodll dll error", "", MB_OK);
}
}

if (hinstLibDLL)
{
lpFnDll_Get_IO = (LPFNDDLGETIOSPACE)GetProcAddress(GetModuleHandle("diodll.dll"),
"GetIoSpaceByte");
lpFnDll_Set_IO = (LPFNDDLSETIOSPACE)GetProcAddress(GetModuleHandle("diodll.dll"),
"SetIoSpaceByte");
}

printf("Input Watch Dog Timer type, 1:Second ; 2:Minute :");
scanf("%d",&unit);
printf("\nInput Timer to countdown:");
scanf("%d", &WDTtimer);
printf("Start to countdown...");
//==Enter MB Pnp Mode==
lpFnDll_Set_IO(0x2e, 0x87);
lpFnDll_Set_IO(0x2e, 0x87);
lpFnDll_Set_IO(0x2e, 0x07);
lpFnDll_Set_IO(0x2f, 0x07); //SET LDN 07
//set LDN07 FA 10 to 11
lpFnDll_Set_IO(0x2e, 0xFA);
WDTDATA = lpFnDll_Get_IO(0x2f);
WDTDATA = setbit(WDTDATA, 0);
lpFnDll_Set_IO(0x2f, WDTDATA);
if (unit == 1)
{
lpFnDll_Set_IO(0x2e, 0xF6);
lpFnDll_Set_IO(0x2f, WDTtimer);
//start watchdog counting
lpFnDll_Set_IO(0x2e, 0xF5);
WDTDATA = lpFnDll_Get_IO(0x2f);
WDTDATA = setbit(WDTDATA, 5);
lpFnDll_Set_IO(0x2f, WDTDATA);
}
```



```
}  
else if (unit == 2)  
{  
  
//set WDT Timer  
  
lpFnDII_Set_IO(0x2e, 0xF6);  
  
lpFnDII_Set_IO(0x2f, WDTtimer);  
//set watchdog time unit to min  
lpFnDII_Set_IO(0x2e, 0xF5);  
WDTDATA = lpFnDII_Get_IO(0x2f);  
  
WDTDATA = setbit(WDTDATA, 3);  
lpFnDII_Set_IO(0x2f, WDTDATA);  
//start watchdog counting  
lpFnDII_Set_IO(0x2e, 0xF5);  
WDTDATA = lpFnDII_Get_IO(0x2f);  
WDTDATA = setbit(WDTDATA, 5);  
lpFnDII_Set_IO(0x2f, WDTDATA);  
}  
system("pause");  
return 0;  
}
```

This page is intentionally left blank.

APPENDIX B WAKE on LAN

How to Set up Wake on LAN

Please follow the following steps to set up Wake on LAN on Windows 11.

1. Press "  " w/ "S" or press "  " on Windows desktop.
2. Enter "proset" in red area.

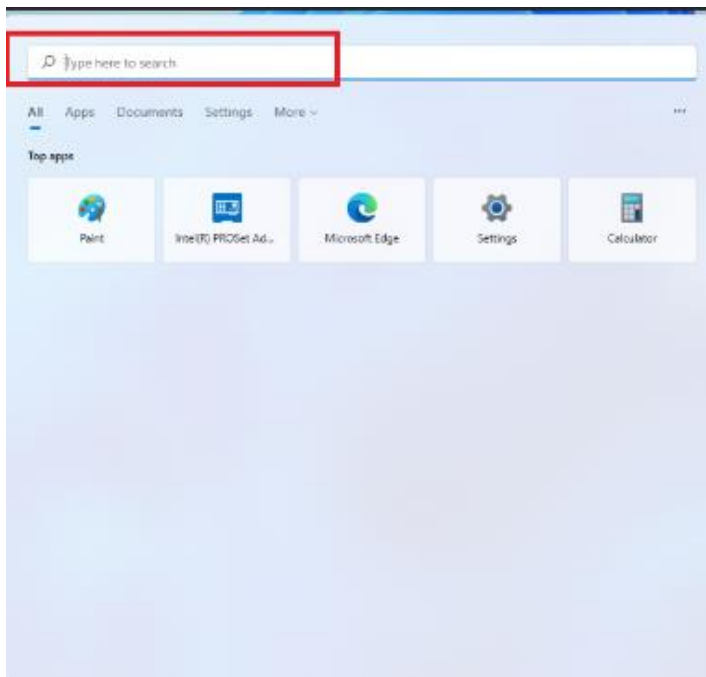

3. Select "Run as administrator"

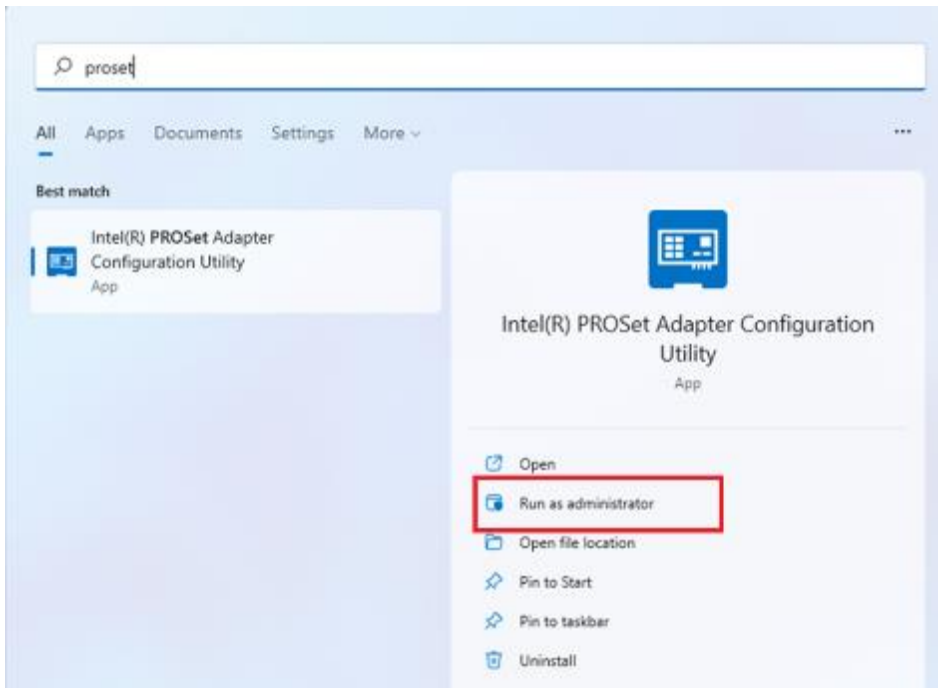

4. Select a LAN port (1) which will support "Wake on LAN", then enable functionality you need under "Adapter Settings" (2)
5. Press "Any Changes" (3).

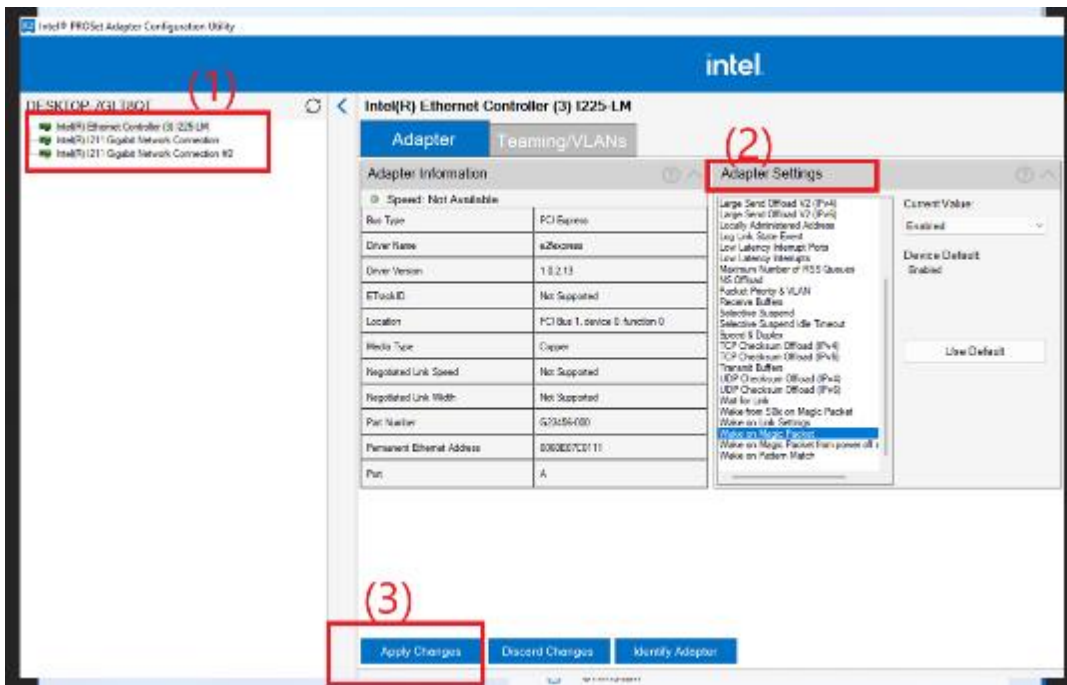

**Please follow step 4 and step 5 to set the other LAN ports for "Wake on LAN"

6. Press "Windows" w/ "S" or press "Search" on Windows desktop.
7. Enter "control panel" in red area.

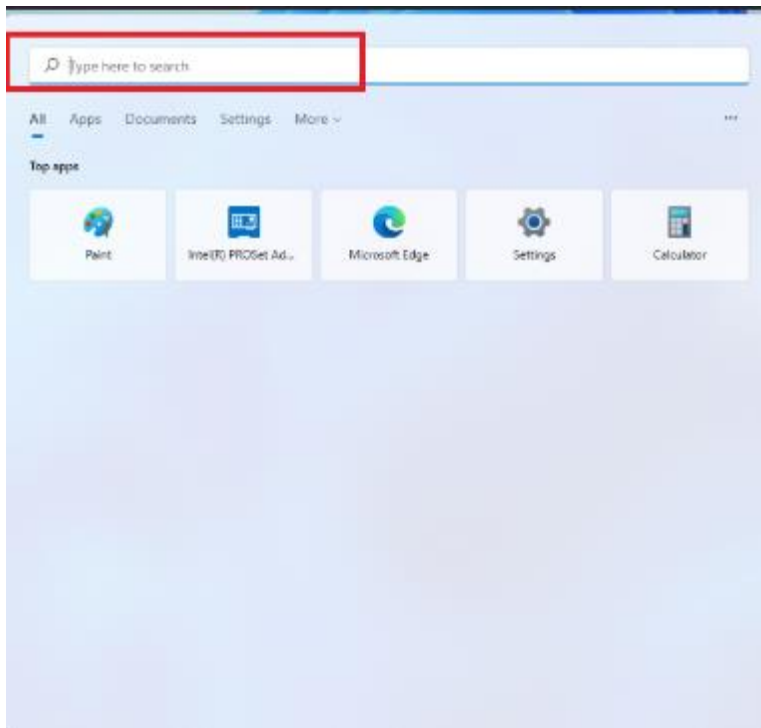

8. Select "Open".

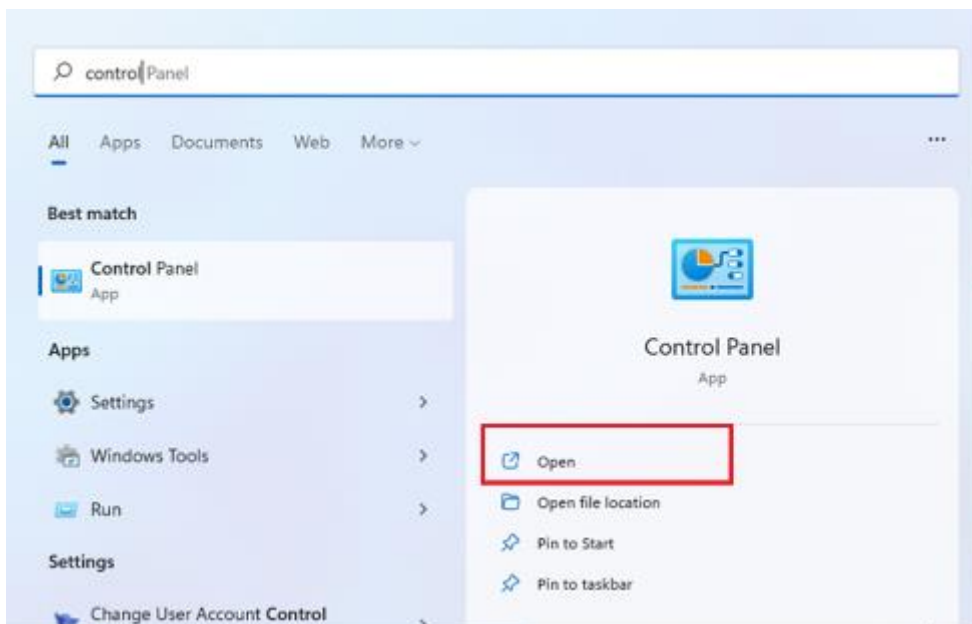

9. Press Power options → Change what the power button do

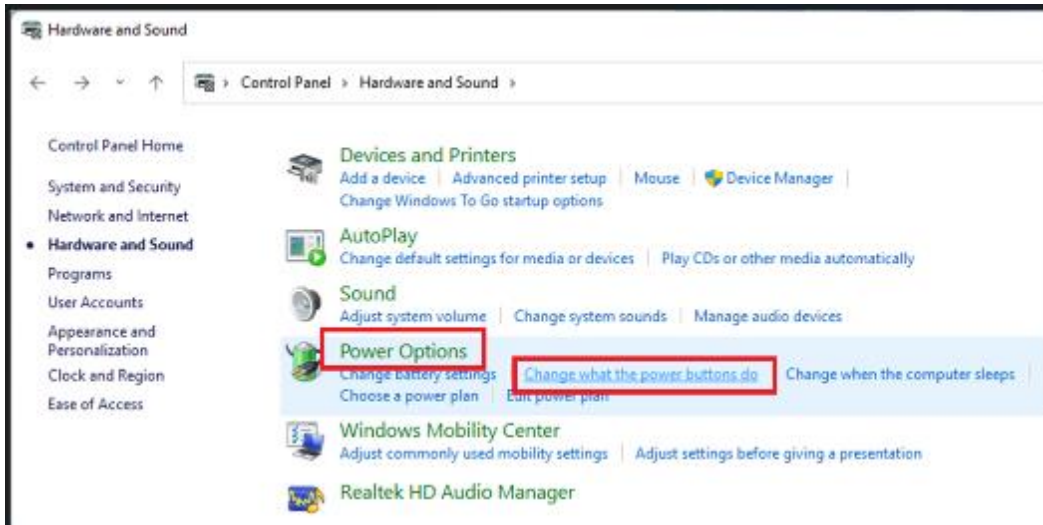

10. Remove "  " from "Turn on fast startup", the press "Save changes".

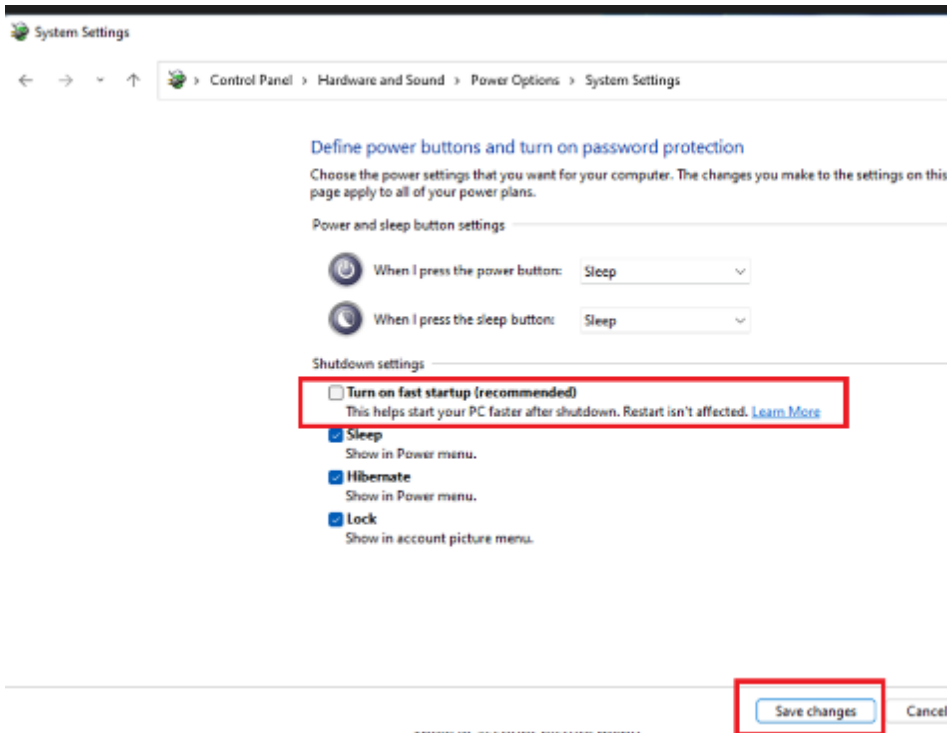

11. Reboot the system to enable the above settings. Installation is completed.

APPENDIX D HDD HOT-SWAPPABLE

HDD HOT-SWAPPABLE

IPC960A/IPC962A/IPC964A offers two hot-swapp 2.5" HDD or SSD, people can easy install and replace the storages by following steps.

Using HDD hot-swappable function

Step 1 Please press "Delete" after turn on the system, then following the path to enable the Hot Plug function.

BIOS setup→Advanced→SATA Controller(s)→SATA Mode Selection→

Serial ATA Port→Hot Plug enable

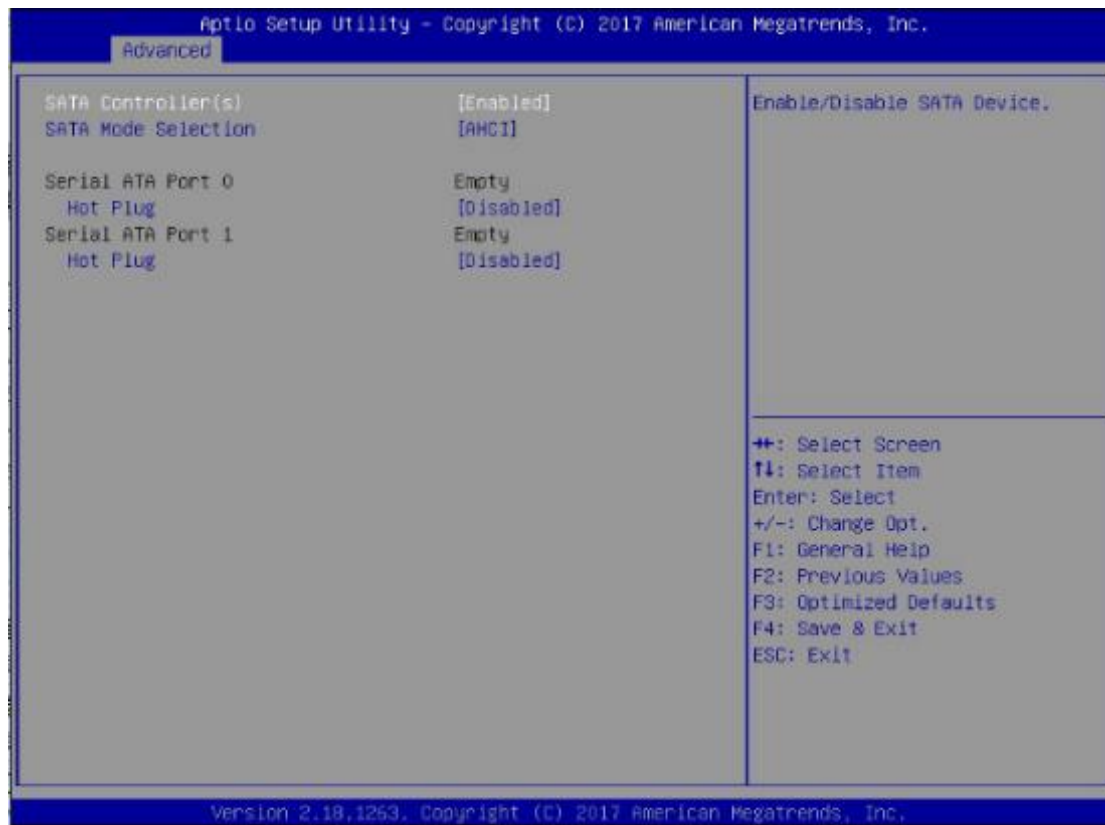

Step 2 System auto reboot, installation completed.

Removing Hot-Swappable storage

- Step 1 Click "".
- Step 2 Select "Eject xxxx".
- Step 3 Remove the HDD device after "Safe To Remove Hardware" shown.

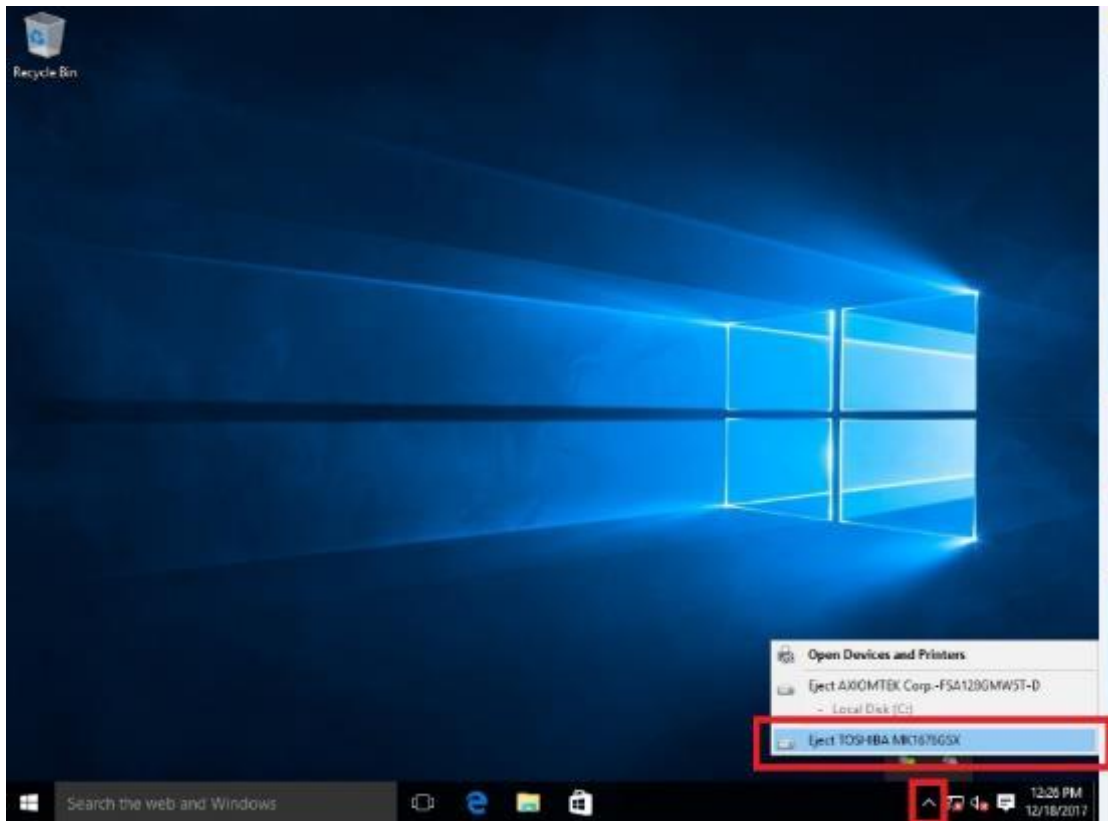

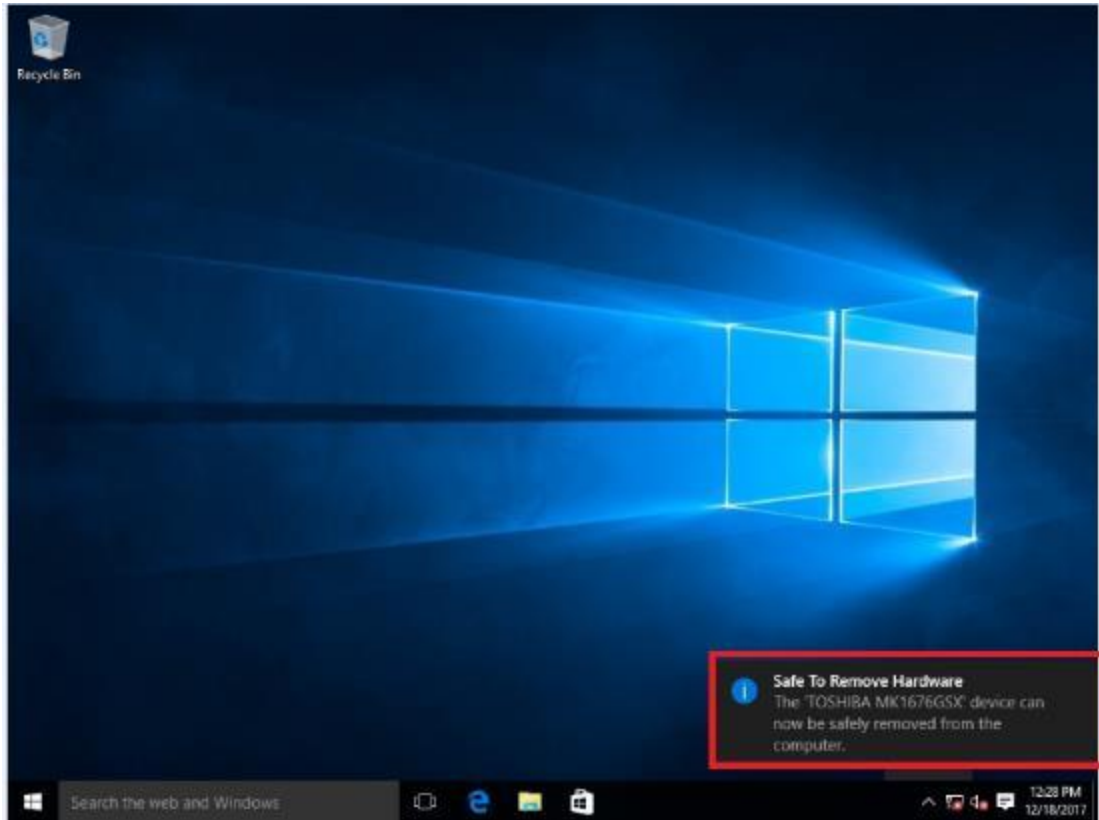

Note: Please close the programs which are in using before removing the devices.